

Product: TRACK-TYPE TRACTOR

Model: D5M TRACK-TYPE TRACTOR 4JS

Configuration: D5M XL & D5M LGP TRACTORS / POWERSHIFT / 4JS00001-UP (MACHINE) POWERED BY 3116 ENGINE

Disassembly and Assembly

446 and 446B Backhoe Loaders, Lexion 450 Combine, 3114 and 3116 Engines, IT18F Integrated Toolcarrier, D6M Track-Type Tractor and 928F, 950F and 950G Wheel Loaders

Media Number -SEN3611-18

Publication Date -01/05/2009

Date Updated -27/05/2009

i01930098

Rocker Shaft and Pushrod - Remove

SMCS - 1102-011; 1208-011

Removal Procedure

Start By:

- a. Remove the valve mechanism cover. Refer to Disassembly and Assembly, "Valve Mechanism Cover - Remove and Install".

NOTICE

Keep all parts clean from contaminants.

Contaminants may cause rapid wear and shortened component life.

Note: For information on reusability of components of the rocker shaft, refer to Guideline For Reusable Parts And Salvage Operations, SEBF8267, "Rocker Arms and Rocker Arm Shafts for 3114 and 3116 Engines".



Illustration 1

g00629575

1. Loosen all rocker arm adjustment screws (3).
 2. Remove bolts (1) from the rocker shaft assembly (2).
 3. Remove rocker shaft assembly (2) from the cylinder head.
 4. Repeat the procedure for each rocker shaft assembly.
 5. Remove the pushrods.
-

Product: TRACK-TYPE TRACTOR

Model: D5M TRACK-TYPE TRACTOR 4JS

Configuration: D5M XL & D5M LGP TRACTORS / POWERSHIFT / 4JS00001-UP (MACHINE) POWERED BY 3116 ENGINE

Disassembly and Assembly

446 and 446B Backhoe Loaders, Lexion 450 Combine, 3114 and 3116 Engines, IT18F Integrated Toolcarrier, D6M Track-Type Tractor and 928F, 950F and 950G Wheel Loaders

Media Number -SEN3611-18

Publication Date -01/05/2009

Date Updated -27/05/2009

i01930139

Rocker Shaft - Disassemble

SMCS - 1102-015

Disassembly Procedure

Table 1

Required Tools			
Tool	Part Number	Part Description	Qty
A	6V-0083	Emery Polishing Paper	1

Start By:

- Remove the rocker shaft and the pushrods. Refer to Disassembly and Assembly, "Rocker Shaft and Pushrod - Remove".

NOTICE

Keep all parts clean from contaminants.

Contaminants may cause rapid wear and shortened component life.

Note: For information on reusability of components of the rocker shaft, refer to Guideline For Reusable Parts And Salvage Operations, SEBF8267, "Rocker Arms and Rocker Arm Shafts for 3114 and 3116 Engines".

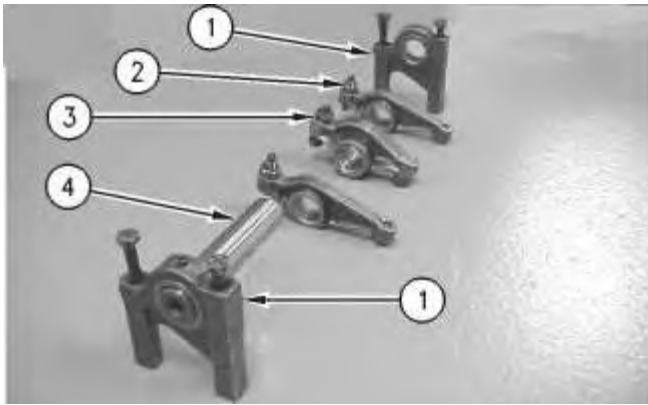

Illustration 1

g00629612

1. Remove support bracket (1) from rocker shaft assembly (4).
2. Remove valve rocker arms (2) and unit injector rocker arm (3) from rocker shaft assembly (4).

Note: Do not force the rocker arms from the rocker shaft assembly. If necessary, use a piece of Tooling (A) to lightly buff the surface of the shaft to aid in removal .

3. Check the adjustment screws on valve rocker arms (2) and unit injector rocker arm (3) for damage.
4. Inspect rocker shaft assembly (4) for scratches and cracks.

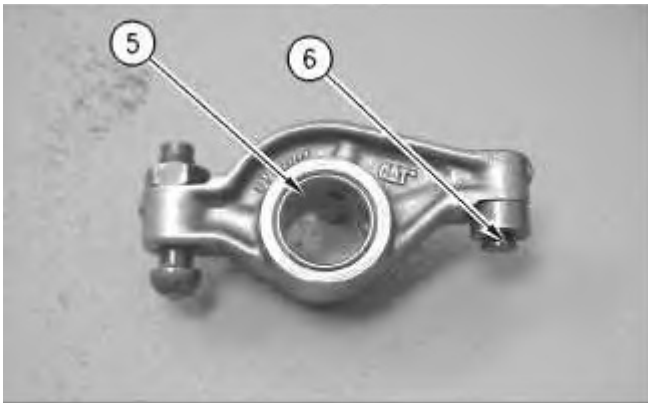

Illustration 2

g00630277

5. Inspect bearing (5) on unit injector rocker arm (3). The bore in the rocker arm is 24.808 ± 0.20 mm (0.9767 ± 0.0079 inch). Refer to Specification, "Valve Rocker Arm and Lifters". Replace the bearing, if necessary.
6. Ensure that button (6) on unit injector rocker arm (3) is not damaged. Also ensure that the retaining ring for button (6) is in place.

Product: TRACK-TYPE TRACTOR

Model: D5M TRACK-TYPE TRACTOR 4JS

Configuration: D5M XL & D5M LGP TRACTORS / POWERSHIFT / 4JS00001-UP (MACHINE) POWERED BY 3116 ENGINE

Disassembly and Assembly

446 and 446B Backhoe Loaders, Lexion 450 Combine, 3114 and 3116 Engines, IT18F Integrated Toolcarrier, D6M Track-Type Tractor and 928F, 950F and 950G Wheel Loaders

Media Number -SEN3611-18

Publication Date -01/05/2009

Date Updated -27/05/2009

i01930194

Rocker Shaft - Assemble

SMCS - 1102-016

Assembly Procedure

NOTICE

Keep all parts clean from contaminants.

Contaminants may cause rapid wear and shortened component life.

Note: For information on reusability of components of the rocker shaft, refer to Guideline For Reusable Parts And Salvage Operations, SEBF8267, "Rocker Arms and Rocker Arm Shafts for 3114 and 3116 Engines".

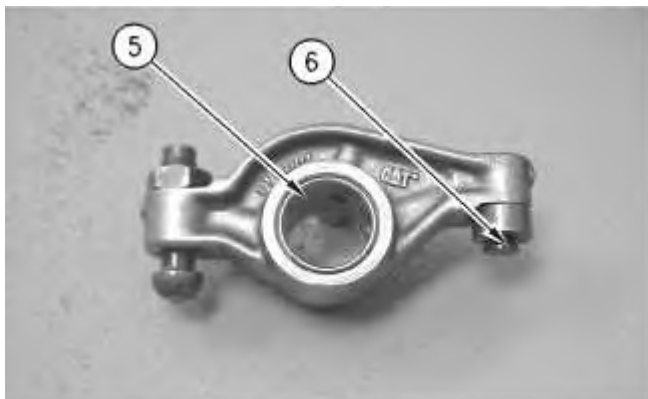

1. Install button (6) and the retaining ring, if necessary.
2. Place clean engine oil on a new bearing (5) prior to installation.
3. Ensure that the oil hole in bearing (5) is aligned with the oil hole in the rocker arm. Hone the bearing, if necessary. Refer to the Specifications Module for the correct dimensions.

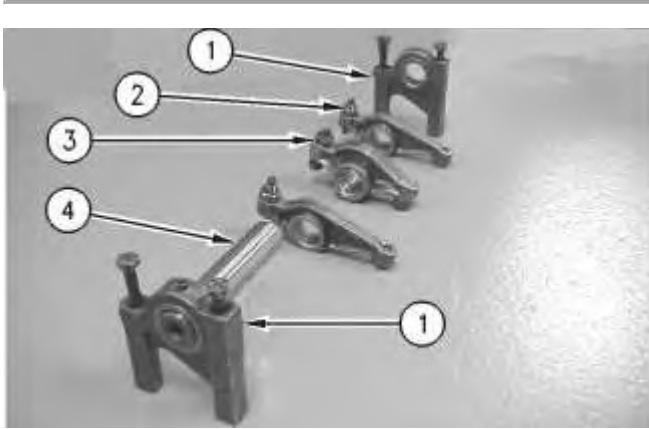

Illustration 2

4. Lubricate rocker shaft assembly (4) with clean engine oil.
5. Install valve rocker arms (2) and unit injector rocker arm (3) on rocker shaft assembly (4).
6. Install support bracket (1) on rocker shaft assembly (4).

End By:

- a. Install the rocker shaft and the pushrods. Refer to Disassembly and Assembly, "Rocker Shaft and Pushrod - Install".
-

Product: TRACK-TYPE TRACTOR

Model: D5M TRACK-TYPE TRACTOR 4JS

Configuration: D5M XL & D5M LGP TRACTORS / POWERSHIFT / 4JS00001-UP (MACHINE) POWERED BY 3116 ENGINE

Disassembly and Assembly

446 and 446B Backhoe Loaders, Lexion 450 Combine, 3114 and 3116 Engines, IT18F Integrated Toolcarrier, D6M Track-Type Tractor and 928F, 950F and 950G Wheel Loaders

Media Number -SEN3611-18

Publication Date -01/05/2009

Date Updated -27/05/2009

i02736495

Rocker Shaft and Pushrod - Install

SMCS - 1102-012; 1208-012

Installation Procedure

Table 1

Required Tools			
Tool	Part Number	Part Description	Qty
A	146-2597	Pushrod Holder	1

NOTICE

Keep all parts clean from contaminants.

Contaminants may cause rapid wear and shortened component life.

Note: For information on reusability of components of the rocker shaft, refer to Guideline For Reusable Parts And Salvage Operations, SEBF8267, "Rocker Arms and Rocker Arm Shafts for 3114 and 3116 Engines".

1. Install the pushrods in the engine. The base of the pushrod should be in the seat of the pushrod lifter.
 2. Install Tooling (A).
-



Illustration 1

g00629575

3. Position rocker shaft assembly (2) in the engine. Line up the pushrods with the rocker arms.
4. Install bolts (1) in rocker shaft assembly (2). Tighten the bolts to a torque of 28 ± 7 N·m (21 ± 5 lb ft).
5. Remove Tooling (A) from the pushrods.
6. Adjust the valve lash on all of the adjustment screws. Refer to Testing and Adjusting, "Engine Valve Lash - Inspect/Adjust".
7. Repeat the procedure for the remaining rocker shaft assemblies.

End By:

- a. Install the valve mechanism cover. Refer to Disassembly and Assembly, "Valve Mechanism Cover - Remove and Install".
-

Product: TRACK-TYPE TRACTOR

Model: D5M TRACK-TYPE TRACTOR 4JS

Configuration: D5M XL & D5M LGP TRACTORS / POWERSHIFT / 4JS00001-UP (MACHINE) POWERED BY 3116 ENGINE

Disassembly and Assembly

446 and 446B Backhoe Loaders, Lexion 450 Combine, 3114 and 3116 Engines, IT18F Integrated Toolcarrier, D6M Track-Type Tractor and 928F, 950F and 950G Wheel Loaders

Media Number -SEN3611-18

Publication Date -01/05/2009

Date Updated -27/05/2009

i01935828

Cylinder Head - Remove

SMCS - 1100-011

Removal Procedure

Start By:

- a. Remove the fuel filter base. Refer to Disassembly and Assembly, "Fuel Filter Base - Remove and Install".
- b. Remove the governor. Refer to Disassembly and Assembly, "Governor - Remove".
- c. Remove the fuel control linkage. Refer to Disassembly and Assembly, "Fuel Injection Control Linkage - Remove".
- d. Remove the unit injectors. Refer to Disassembly and Assembly, "Unit Injector - Remove".
- e. Remove the water temperature regulator housing. Refer to Disassembly and Assembly, "Water Temperature Regulator Housing - Remove and Install".
- f. Remove the inlet manifold. Refer to Disassembly and Assembly, "Inlet Manifold - Remove".
- g. Remove the exhaust manifold. Refer to Disassembly and Assembly, "Exhaust Manifold - Remove and Install".

NOTICE

Keep all parts clean from contaminants.

Contaminants may cause rapid wear and shortened component life.

NOTICE

Care must be taken to ensure that fluids are contained during performance of inspection, maintenance, testing, adjusting, and repair of the product. Be prepared to collect the fluid with suitable containers before opening any compartment or disassembling any component containing fluids.

Refer to Special Publication, NENG2500, "Dealer Service Tool Catalog" for tools and supplies suitable to collect and contain fluids on Cat products.

Dispose of all fluids according to local regulations and mandates.

Note: For information on the reusability of the cylinder head, refer to Guideline For Reusable Parts And Salvage Operations, SEBF8218, "Specifications for Cylinder Head Assemblies 3114, 3116, and 3126 Engines" and Guideline For Reusable Parts And Salvage Operations, SEBF8162, "Procedure to Measure and Salvage Cylinder Head Assemblies and Related Components".

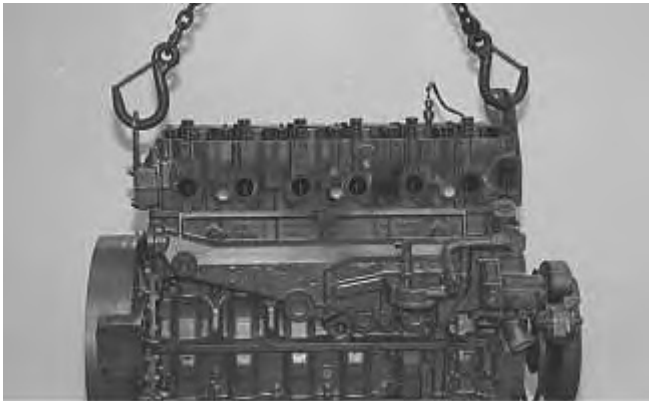

Illustration 1
Typical example

g01007597

1. Attach a suitable lifting device to the cylinder head.
-

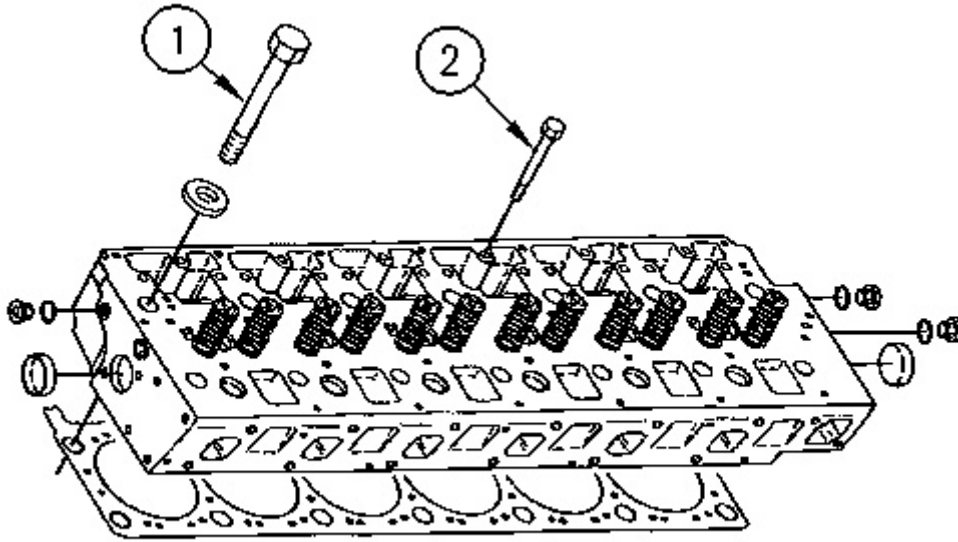

Illustration 2

g00654709

2. Remove bolts (1) and (2) that hold the cylinder head to the cylinder block. Carefully remove the cylinder head from the cylinder block. The cylinder head for the 3116 engine weighs approximately 85 kg (187 lb).

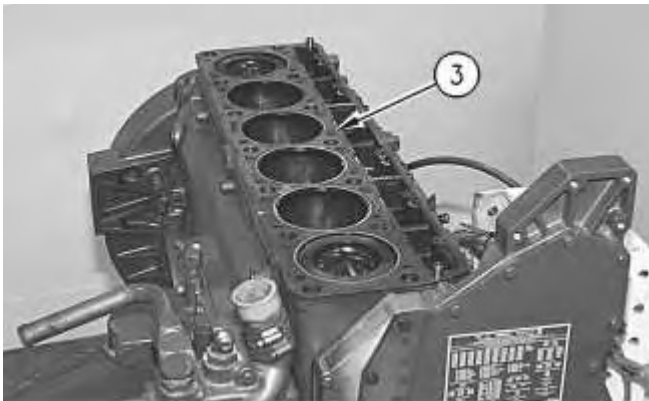

Illustration 3

g00611342

3. Remove cylinder head gasket (3).
-

Product: TRACK-TYPE TRACTOR

Model: D5M TRACK-TYPE TRACTOR 4JS

Configuration: D5M XL & D5M LGP TRACTORS / POWERSHIFT / 4JS00001-UP (MACHINE) POWERED BY 3116 ENGINE

Disassembly and Assembly

446 and 446B Backhoe Loaders, Lexion 450 Combine, 3114 and 3116 Engines, IT18F Integrated Toolcarrier, D6M Track-Type Tractor and 928F, 950F and 950G Wheel Loaders

Media Number -SEN3611-18

Publication Date -01/05/2009

Date Updated -27/05/2009

i04147334

Cylinder Head - Install

SMCS - 1100-012

Installation Procedure

Table 1

Required Tools			
Tool	Part Number	Part Description	Qty
A	6V-4876	Lubricant	1

NOTICE

Keep all parts clean from contaminants.

Contaminants may cause rapid wear and shortened component life.

Note: For information on the reusability of the cylinder head, refer to Guideline For Reusable Parts And Salvage Operations, SEBF8218, "Specifications for Cylinder Head Assemblies 3114, 3116, and 3126 Engines" and Guideline For Reusable Parts And Salvage Operations, SEBF8162, "Procedure to Measure and Salvage Cylinder Head Assemblies and Related Components".

1. Thoroughly clean the mating surfaces of the cylinder head and the cylinder block.
-

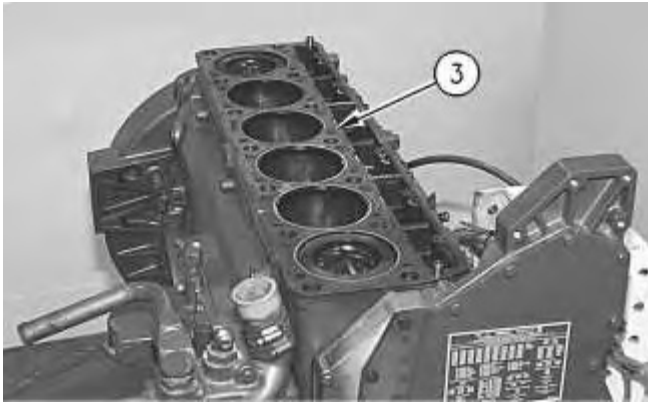

Illustration 1

g00611342

Typical example

2. Install a new cylinder head gasket (3) .

Note: For information on the cylinder head gasket for 3116 engines, refer to Special Instruction, SEHS9395, "3116 Cylinder Head Gasket Usage".

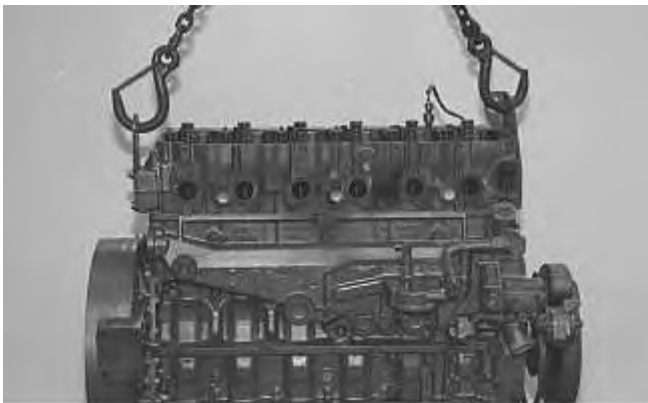

Illustration 2

g01007597

Typical example

- Note:** To avoid damage to the cylinder head gasket, use guide bolts of an appropriate size to install the cylinder head.
3. Attach a suitable lifting device to the cylinder head. Position the cylinder head assembly onto the dowels in the cylinder block. Lower the cylinder head onto the cylinder block.
-

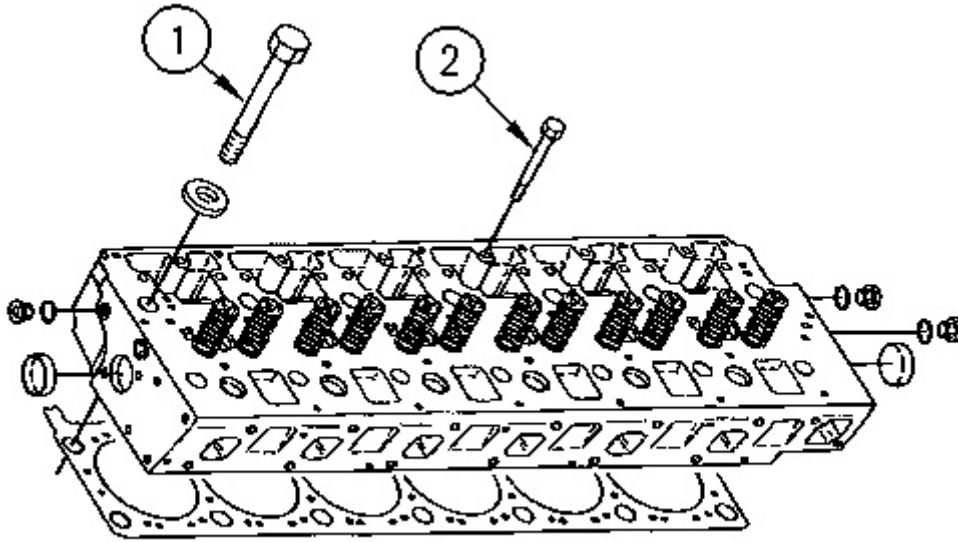

Illustration 3

g00654709

4. Inspect the condition of cylinder head bolts (1) and (2) . For information on the reusability of the bolts, refer to Guideline For Reusable Parts And Salvage Operations, SEBF8301, "Inspection and Reuse of Critical Fasteners Used in All Engines". Replace cylinder head bolts (1) and (2) , if necessary.
5. Lubricate cylinder head bolts (1) and (2) and both sides of the washers with Tooling (A) . Install cylinder head bolts (1) and (2) . Follow Step 6 for the correct tightening procedure.

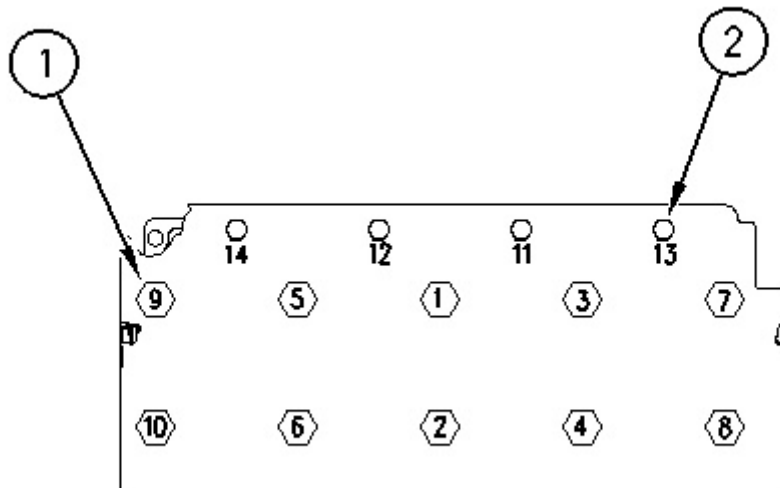

Illustration 4

g00641677

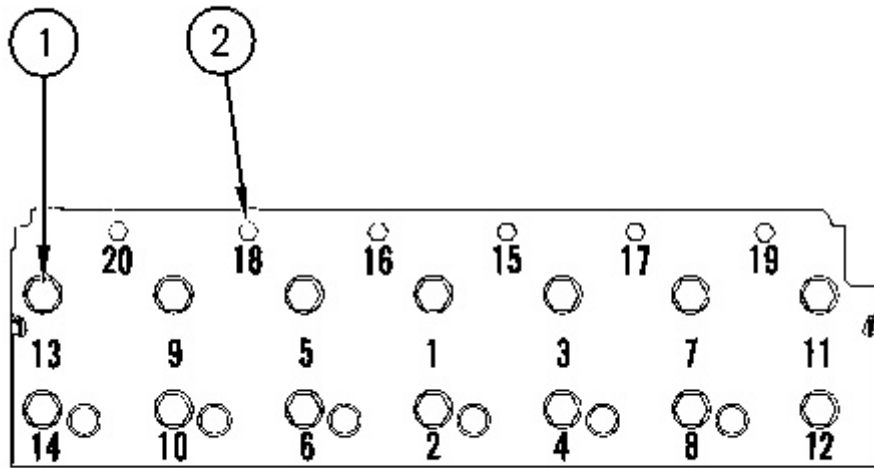

Illustration 5

g00611358

6. Tighten the cylinder head bolts according to the following procedure:
7. Tighten bolts (1) through bolt (14) in a numerical sequence to a torque of 300 ± 15 N·m (221 ± 11 lb ft).
8. Loosen bolts (1) through bolt (14) to a torque of 0 N·m.
9. Tighten bolts (1) through bolt (14) again in a numerical sequence to a torque of 130 ± 15 N·m (96 ± 11 lb ft).
10. Retighten bolts (1) through bolt (14) again in a numerical sequence to a torque of 130 ± 15 N·m (96 ± 11 lb ft).
11. Turn bolts (1) through bolt (14) by numerical sequence an additional 90° (1/4 turn).
12. Tighten bolt (15) through bolt (20) in a numerical sequence to a torque of 55 ± 7 N·m (41 ± 5 lb ft).

End By:

- a. Install the exhaust manifold. Refer to Disassembly and Assembly, "Exhaust Manifold - Remove and Install".
 - b. Install the inlet manifold. Refer to Disassembly and Assembly, "Inlet Manifold - Install".
 - c. Install the water temperature regulator housing. Refer to Disassembly and Assembly, "Water Temperature Regulator Housing- Remove and Install".
 - d. Install the unit injectors. Refer to Disassembly and Assembly, "Unit Injector - Install".
 - e. Install the fuel control linkage. Refer to Disassembly and Assembly, "Fuel Injection Control Linkage - Install".
 - f. Install the governor. Refer to Disassembly and Assembly, "Governor - Install".
 - g. Install the fuel filter base. Refer to Disassembly and Assembly, "Fuel Filter Base - Remove and Install".
-

Product: TRACK-TYPE TRACTOR

Model: D5M TRACK-TYPE TRACTOR 4JS

Configuration: D5M XL & D5M LGP TRACTORS / POWERSHIFT / 4JS00001-UP (MACHINE) POWERED BY 3116 ENGINE

Disassembly and Assembly

446 and 446B Backhoe Loaders, Lexion 450 Combine, 3114 and 3116 Engines, IT18F Integrated Toolcarrier, D6M Track-Type Tractor and 928F, 950F and 950G Wheel Loaders

Media Number -SEN3611-18

Publication Date -01/05/2009

Date Updated -27/05/2009

i01930413

Lifter Group - Remove and Install

SMCS - 1209-010

Removal Procedure

Start By:

- a. Remove the rocker shaft and the pushrods. Refer to Disassembly and Assembly, "Rocker Shaft and Pushrod - Remove".

NOTICE

Keep all parts clean from contaminants.

Contaminants may cause rapid wear and shortened component life.

NOTICE

Care must be taken to ensure that fluids are contained during performance of inspection, maintenance, testing, adjusting, and repair of the product. Be prepared to collect the fluid with suitable containers before opening any compartment or disassembling any component containing fluids.

Refer to Special Publication, NENG2500, "Dealer Service Tool Catalog" for tools and supplies suitable to collect and contain fluids on Cat products.

Dispose of all fluids according to local regulations and mandates.

Note: For information on reusability of components of the lifter group, refer to Guideline For Reusable Parts And Salvage Operations, SEBF8264, "Camshaft Roller Followers Used in 3114 and 3116 Engines" and Guideline For Reusable Parts And Salvage Operations, SEBF8067, "Slipper Followers and Camshaft Roller Followers".

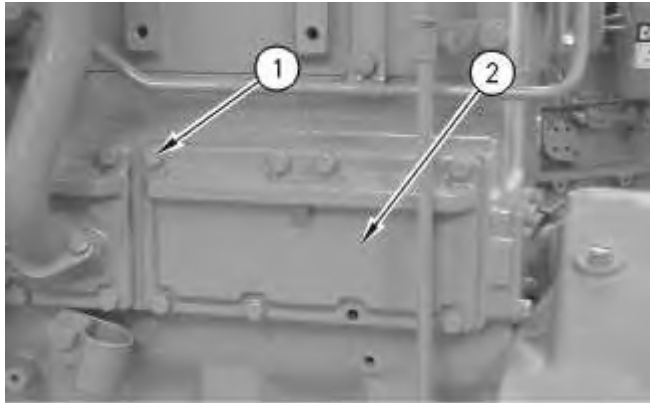

Illustration 1

g00747310

1. Remove bolts (1) from cover (2).
2. Carefully remove cover (2) and the gasket.

Note: It may be necessary to remove the governor in order to remove the cover at the front of the engine.

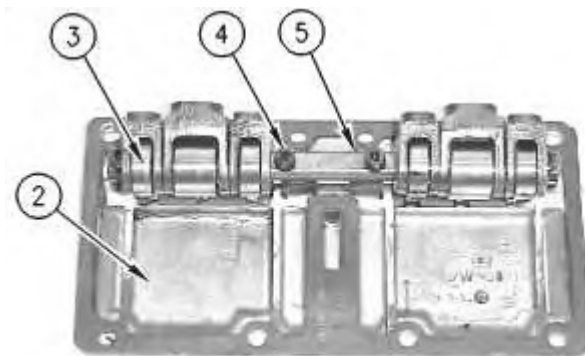

Illustration 2

g00629677

3. Remove bolts (4), lifter shaft (5), and lifters (3) from cover (2).

Installation Procedure

NOTICE

Keep all parts clean from contaminants.

Contaminants may cause rapid wear and shortened component life.

Note: For information on reusability of components of the lifter group, refer to Guideline For Reusable Parts And Salvage Operations, SEBF8264, "Camshaft Roller Followers Used in 3114 and 3116 Engines" and Guideline For Reusable Parts And Salvage Operations, SEBF8067, "Slipper Followers and Camshaft Roller Followers".

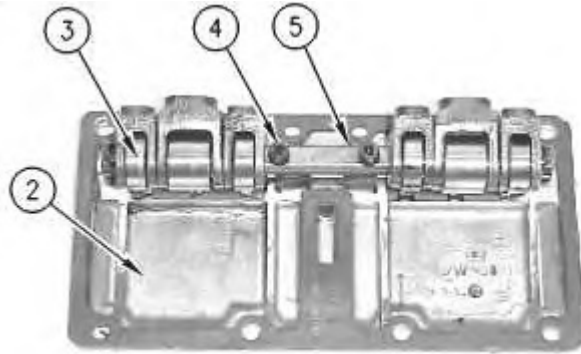

Illustration 3

g00629677

1. Position lifters (3) and lifter shaft (5) on cover (2). Install bolts (4).

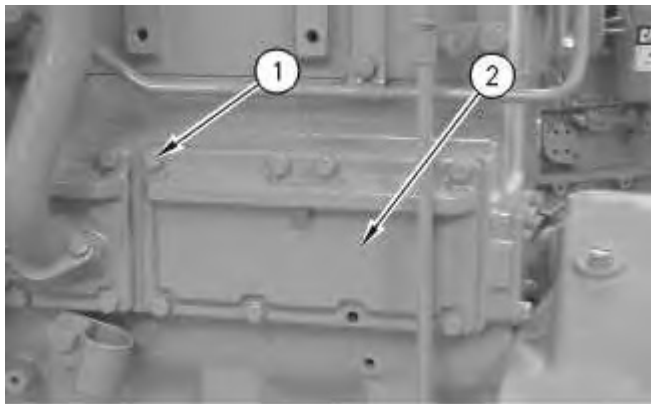

Illustration 4

g00747310

2. Position the gasket and cover (2) on the engine.
3. Install bolts (1) in cover (2).

End By:

- a. Install the rocker shaft and the pushrods. Refer to Disassembly and Assembly, "Rocker Shaft and Pushrod - Install".
-

Product: TRACK-TYPE TRACTOR

Model: D5M TRACK-TYPE TRACTOR 4JS

Configuration: D5M XL & D5M LGP TRACTORS / POWERSHIFT / 4JS00001-UP (MACHINE) POWERED BY 3116 ENGINE

Disassembly and Assembly

446 and 446B Backhoe Loaders, Lexion 450 Combine, 3114 and 3116 Engines, IT18F Integrated Toolcarrier, D6M Track-Type Tractor and 928F, 950F and 950G Wheel Loaders

Media Number -SEN3611-18

Publication Date -01/05/2009

Date Updated -27/05/2009

i01930426

Camshaft - Remove

SMCS - 1210-011

Removal Procedure

Start By:

- a. Remove the governor. Refer to Disassembly and Assembly, "Governor - Remove".
- b. Remove the side covers. Refer to Disassembly and Assembly, "Lifter Group - Remove and Install".
- c. Remove the front cover. Refer to Disassembly and Assembly, "Front Cover - Remove".

NOTICE

Keep all parts clean from contaminants.

Contaminants may cause rapid wear and shortened component life.

NOTICE

Care must be taken to ensure that fluids are contained during performance of inspection, maintenance, testing, adjusting, and repair of the product. Be prepared to collect the fluid with suitable containers before opening any compartment or disassembling any component containing fluids.

Refer to Special Publication, NENG2500, "Dealer Service Tool Catalog" for tools and supplies suitable to collect and contain fluids on Cat products.

Dispose of all fluids according to local regulations and mandates.

Note: For information on reusability of the camshaft, refer to Guideline For Reusable Parts And Salvage Operations, SEBF8097, "Camshaft Measurement", Guideline For Reusable Parts And Salvage Operations, SEBF8146, "Visual Inspection of Camshafts", and Guideline For Reusable Parts And Salvage Operations, SEBF8251, "Specifications for Measurement of Camshafts in 3114/3116 Engines". For information on reusability of the camshaft gear, refer to Guideline For Reusable Parts And Salvage Operations, SEBF8045, "Timing Gears for All Engines".

Note: The air compressor was removed in order to accommodate the engine repair stand.

Note: It is not necessary to remove the cylinder head for removal of the camshaft.

1. Turn the crankshaft to top center compression stroke for the No. 1 piston. Install the timing bolt in the flywheel. This is for timing during installation.



Illustration 1

g01007643

Typical example

2. Ensure that timing mark (1) on the camshaft gear is aligned with timing mark (2) on the idler gear.
-

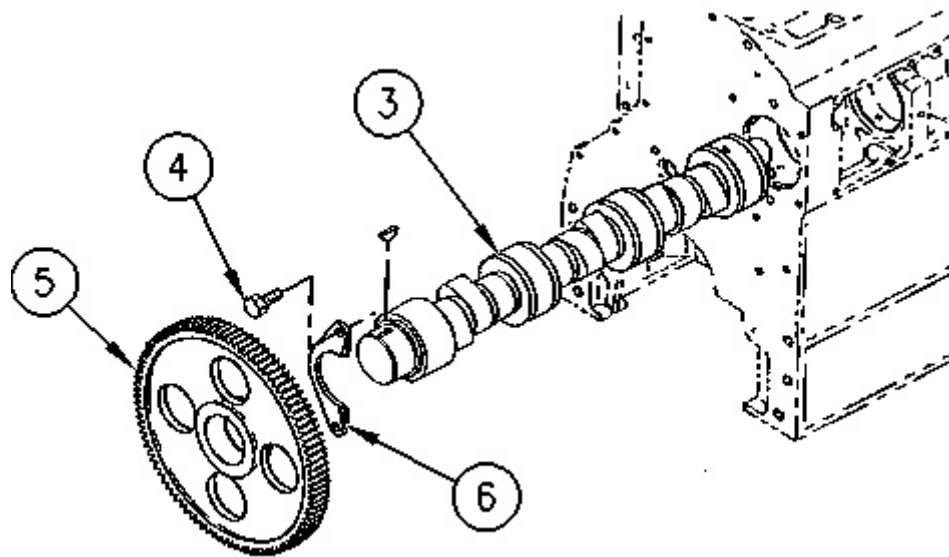

Illustration 2

g01007645

3. Remove bolts (4) and camshaft retainer plate (6).
 4. Remove camshaft gear (5) and camshaft (3) from the cylinder block.
-

Product: TRACK-TYPE TRACTOR

Model: D5M TRACK-TYPE TRACTOR 4JS

Configuration: D5M XL & D5M LGP TRACTORS / POWERSHIFT / 4JS00001-UP (MACHINE) POWERED BY 3116 ENGINE

Disassembly and Assembly

446 and 446B Backhoe Loaders, Lexion 450 Combine, 3114 and 3116 Engines, IT18F Integrated Toolcarrier, D6M Track-Type Tractor and 928F, 950F and 950G Wheel Loaders

Media Number -SEN3611-18

Publication Date -01/05/2009

Date Updated -27/05/2009

i01936378

Camshaft - Install

SMCS - 1210-012

Installation Procedure

NOTICE

Keep all parts clean from contaminants.

Contaminants may cause rapid wear and shortened component life.

Note: For information on reusability of the camshaft, refer to Guideline For Reusable Parts And Salvage Operations, SEBF8097, "Camshaft Measurement", Guideline For Reusable Parts And Salvage Operations, SEBF8146, "Visual Inspection of Camshafts", and Guideline For Reusable Parts And Salvage Operations, SEBF8251, "Specifications for Measurement of Camshafts in 3114/3116 Engines". For information on reusability of the camshaft gear, refer to Guideline For Reusable Parts And Salvage Operations, SEBF8045, "Timing Gears for All Engines".

1. Lubricate the camshaft and the camshaft bearings with clean engine oil.
-

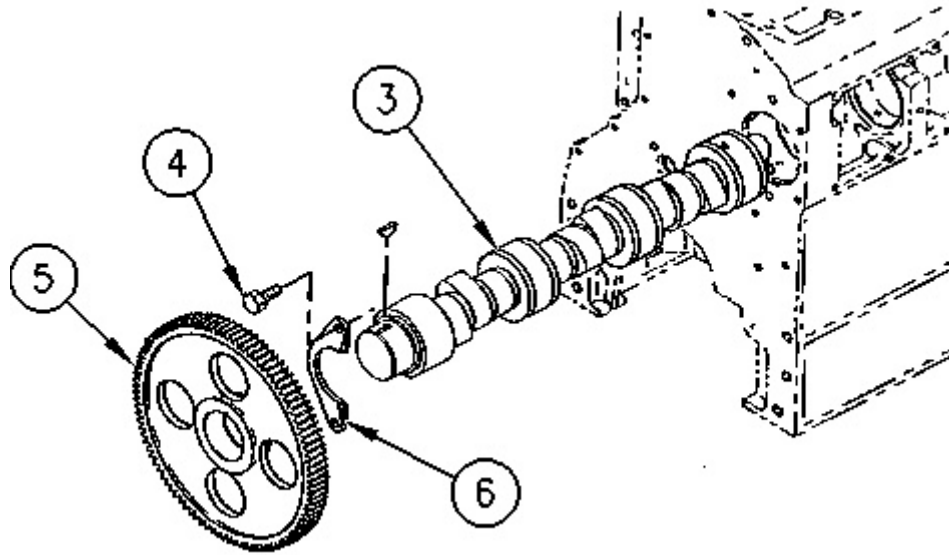

Illustration 1

g01007645

2. Carefully install camshaft (3) and camshaft gear (5) in the engine.

NOTICE

When installing the camshaft, make sure the number one cylinder is at top center of the compression stroke with the timing bolt installed in the flywheel. The camshaft timing is very important. The timing mark on the camshaft drive gear must line up with the timing mark on the idler gear. Refer to the Specifications Manual for more information.



Illustration 2

g01007643

Typical example

3. Ensure that timing mark (1) on the camshaft gear is aligned with timing mark (2) on the idler gear.

Thank you so much for reading.
Please click the “Buy Now!”
button below to download the
complete manual.



After you pay.

You can download the most
perfect and complete manual in
the world immediately.

Our support email:

ebooklibonline@outlook.com