

Product: TRACK-TYPE TRACTOR

Model: D6H XR TRACK-TYPE TRACTOR 5KK

Configuration: D6H XR SERIES II TRACK-TYPE TRACTOR / POWER SHIFT / 5KK00001-UP (MACHINE) POWERED BY 3306 ENGINE

Disassembly and Assembly D6H TRACTOR POWER TRAIN

Media Number -SEN3242-03

Publication Date -01/11/2004

Date Updated -10/01/2017

SEN32420027

Torque Divider

SMCS - 3113-010; 3113-015; 3113-016

Remove And Install Torque Divider

Start By:

- a. remove torque converter outlet relief valve
- b. remove main drive shaft

Tools Needed		A	B
5P9736	Link Bracket	2	2
8S9906	Ratchet Puller		1
	Sheave Hook from 5P9694 Ratchet Hoist		1

1. Remove the floor plate in cab.

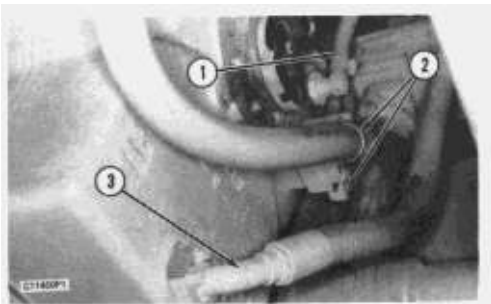

2. Loosen the flange bolts on hose (3) and drain the oil from the torque divider. Disconnect hose (3) from the torque divider when the oil has drained. Remove the O-ring seal from hose (3).
3. Disconnect hose assemblies (2) and remove the O-ring seal. Disconnect hose assembly (1) from the torque divider.

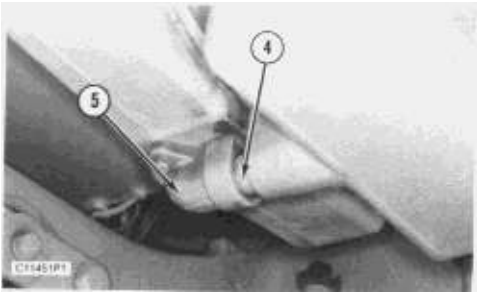

4. Remove elbow (5) from the bottom of the flywheel housing. Remove the O-ring seal from elbow (5).
5. Remove sleeve (4). Remove two O-ring seals from sleeve (4).

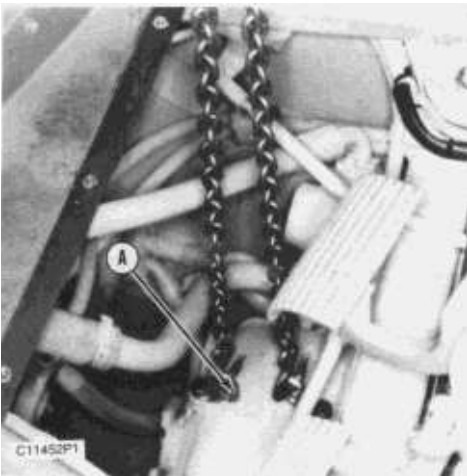

6. The weight of the torque divider is **145 kg (320 lb)**. Install tooling (A) onto the torque divider.
 7. Install tooling (B) to the ceiling of the cab, as shown. Attach tooling (B) to tooling (A).
 8. Remove the twelve bolts that fasten the torque divider to the flywheel housing. Separate the torque divider from the flywheel housing. Use tooling (B) and lower the torque divider to the ground.
 9. Remove the large O-ring seal from the torque divider housing.
- NOTE:** The following steps are for installation of the torque divider.
10. Install the O-ring seal onto the torque divider housing.

11. Use tooling (A), tooling (B), and two 3/8" guide bolts and put the torque divider in position on the flywheel housing.
12. Make sure the teeth are aligned with the flywheel, and install the twelve bolts that hold the torque divider to the flywheel housing. Remove tooling (A) and (B).
13. Install the O-ring seals onto sleeve (4) and elbow (5). Install the sleeve and elbow onto the bottom of the torque divider.
14. Put the O-ring seal in position on hose assemblies (2). Connect hose assemblies (2) and (1) to the torque divider.
15. Put the O-ring seal in position on hose assembly (3) and connect it to the torque divider housing.
16. Install the floor plate in cab.
17. Check the power train oil level and add as necessary. See the Operation and Maintenance Guide for the type of oil and capacity.

End By:

- a. install torque converter outlet relief valve
- b. install main drive shaft

Disassemble Torque Divider

Tools Needed		A	B	C	D	E	F	G
1P1863	Pliers	1						
5P9736	Link Bracket		2					
5P4758	Pliers			1				
6V2156	Link Bracket				1			
1P510	Driver Group					1		
1P520	Driver Group						1	
2P8312	Pliers							1

Start By:

- a. remove torque divider

NOTICE

When a torque converter or divider has a failure, the complete oil system for the torque converter, torque divider and transmission must be thoroughly cleaned. Any foreign material which is not removed from the oil system for the torque converter will move through the hydraulic system for the transmission.

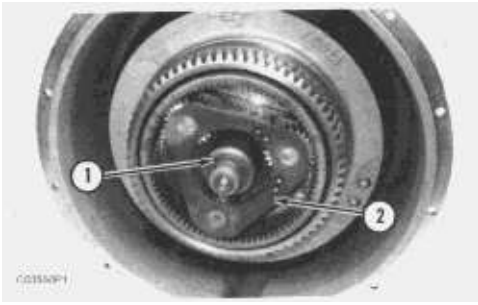

1. Use tool (A), and remove retaining ring (1) from the shaft.
2. Remove planetary carrier (2).

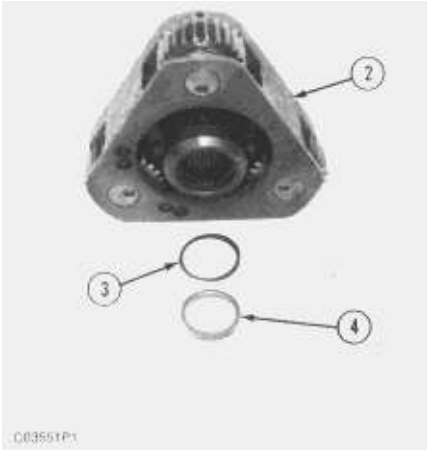

3. Remove retainer (4) and retaining ring (3) from the planetary carrier.

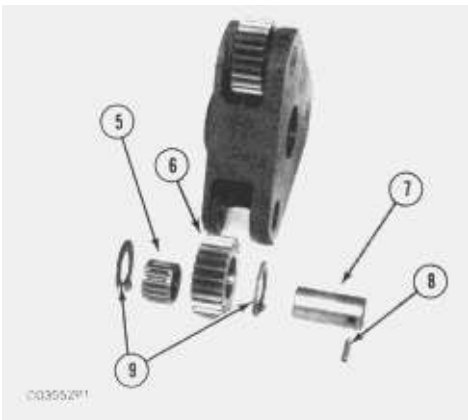

4. Use a hammer and a punch to push pin (8) into shaft (7).
5. Remove shaft (7), two washers (9) and gear (6).
6. Remove bearings (5) from the gear.
7. Remove the pin from shaft (7).

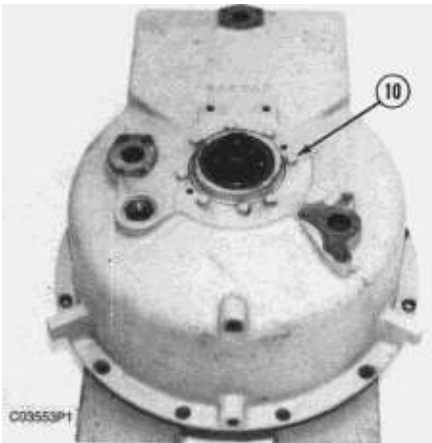

8. Remove the bolt, retainer, O-ring seal and yoke.

9. Put wood blocks under the converter group, as shown, so the cover can be removed.

10. Remove eight bolts (10).

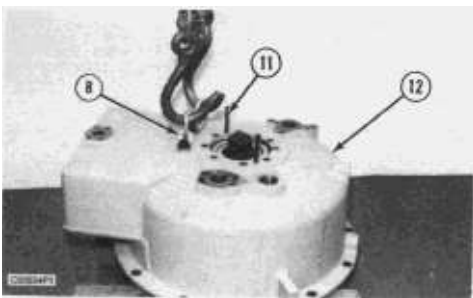

11. The weight of cover (12) is **68 kg (150 lb)**. Install tooling (B), and attach a hoist. Install two 3/8 "-
16 NC forcing screws (11) in the cover. Tighten the forcing screws evenly, and remove cover (12).

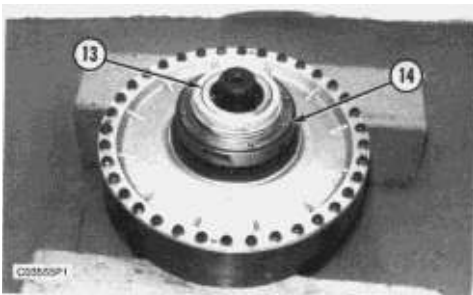

12. Remove O-ring seal (14) and lip-type seal (13).

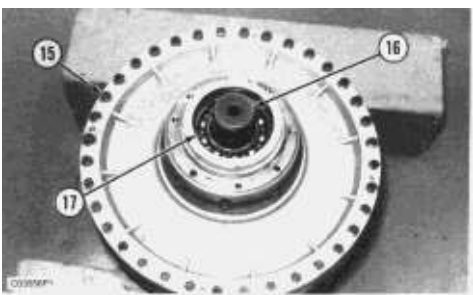

13. Remove two bolts (15) and washers 180° apart from each other. Drain the oil from the converter.

14. Use tool (C), and remove retaining ring (17).

15. Remove shaft assembly (16) and the bearing.

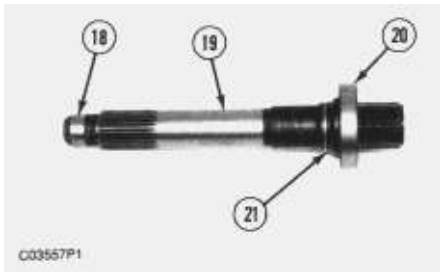

16. Remove seal ring (21) from shaft assembly (19).

17. Remove bearing (20) from the shaft assembly.

NOTE: Race (18) will be destroyed if it is removed from the shaft assembly.

18. Remove race (18) from the shaft assembly if necessary.



19. Remove the remaining thirty-four bolts (15) and washers. Install two 3/8 "-16 NC forcing screws (23) into impeller wheel (22).

20. The weight of impeller wheel (22) and the carrier assembly is **30 kg (66 lb)**. Install tooling (D), and attach a hoist. Tighten two forcing screws (23) evenly, and remove the impeller wheel and carrier assembly.

NOTICE

Use care to avoid causing damage to the stator when it is removed.

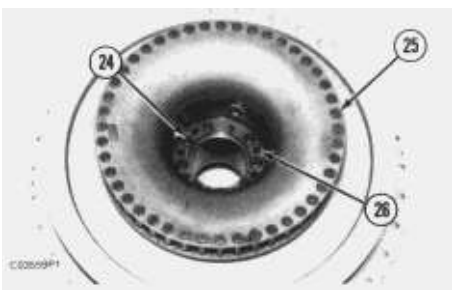

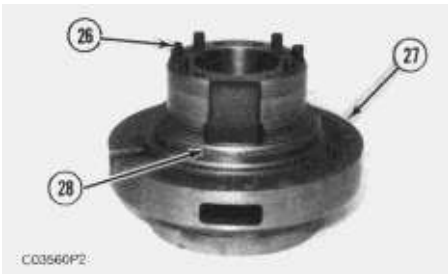

21. Remove eight bolts (24), and remove stator assembly (25).

22. Support the wheel and carrier assembly as close to the center as possible with wood blocks. Use tooling (E) on the inside diameter of pins (26), and remove carrier (27).

23. Remove seal ring (28) and pins (26) from the carrier.

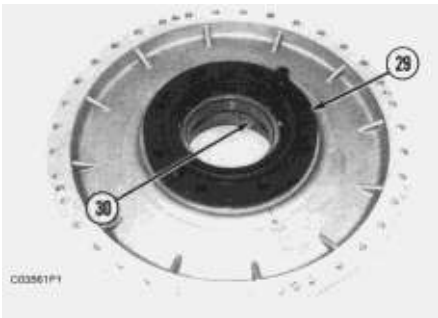

24. Remove the eight bolts that fasten retainer (29) to the impeller wheel. Use two 3/8 "-24 NF forcing screws, and remove retainer (29).

25. Use tool (F), and remove carrier (30) and the bearing.



26. Use tool (F), and remove bearing (31) from carrier (30).

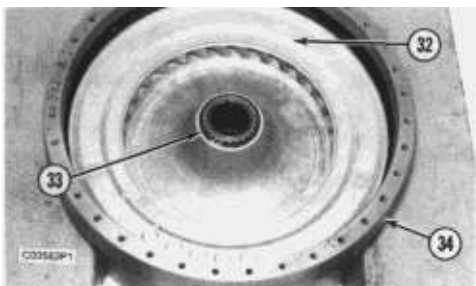

27. Use tool (G), and remove retaining ring (33) from the flange.

28. Remove turbine wheel (32) from housing (34) and the flange assembly. Remove the spacer that is under turbine wheel (32).

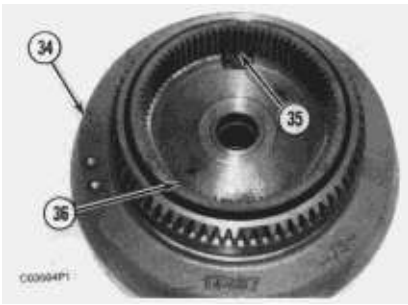

29. The weight of the housing with gear and flange assembly is **35.5 kg (78 lb)**. Turn the housing over, and remove two stop pins (35).

30. Compress the retaining ring, and remove gear (36). Remove the retaining ring.



31. Install two 3/8 "-16 NC forcing screws in flange assembly (37). Tighten the forcing screws evenly, and remove flange assembly (37) from the housing.

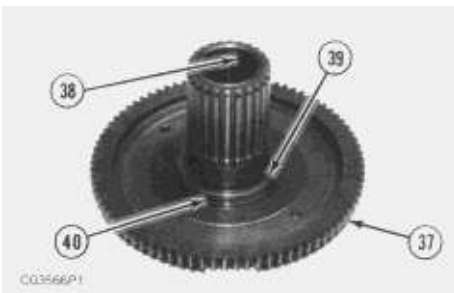

32. Remove seal (40) from carrier (39) on flange assembly (37).

NOTE: Carrier (39) will be destroyed if it is removed from the flange assembly.

33. If carrier (39) is to be removed, use a chisel to break the carrier, and remove it.

34. Use tooling (E), and remove two bearings (38) from flange assembly (37).

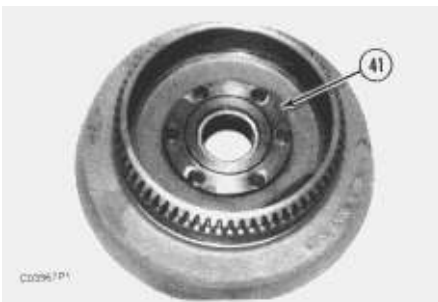

35. Remove the six bolts and retainer (41) from the housing.

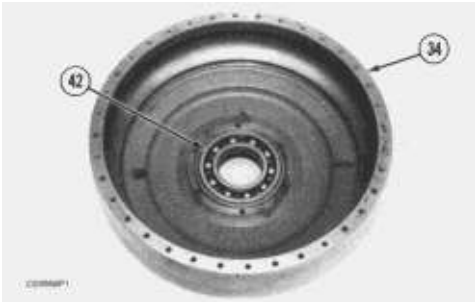

36. Use tooling (F), and remove bearing (42) from housing (34).

Assemble Torque Divider

Tools Needed		A	B	C	D	E	F	G
1P520	Driver Group	1						
1P510	Driver Group		1					
2P8312	Pliers			1				
5P9736	Link Bracket				2			
6V2156	Link Bracket					2		
5P4758	Pliers						1	
1P1863	Pliers							1

NOTE: Before the torque divider is assembled, measurements of certain clearances must be made if the torque divider is to operate with efficiency.

1. Check the clearance between the turbine wheel and stator as follows:



a. Put stator (3) in position in turbine wheel (2). Hold the stator against one side of the turbine wheel, and use a feeler gauge (1) to find the clearance between the stator and the turbine wheel.

b. The clearance across the diameters between the stator and the turbine wheel must be **0.33 to 0.43 mm (.013 to .017 in)**. Check the clearance at four points on the turbine wheel. The maximum permissible clearance across the diameters is **0.76 mm (.030 in)**.

c. The running clearance is one half of the clearance across the diameters between the stator and the turbine wheel. The running clearance must be **0.165 to 0.215 mm (.0065 to .0085 in)**. The maximum permissible running clearance is **0.38 mm (.015 in)**.

2. Check the clearance between the impeller wheel and stator as follows.

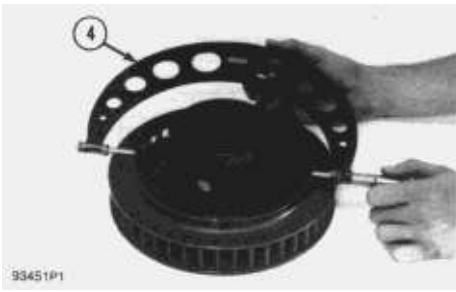

a. Use an outside diameter micrometer (4), and make a measurement of the diameter of the stator flange at four points on stator. Make a record of the lowest reading.

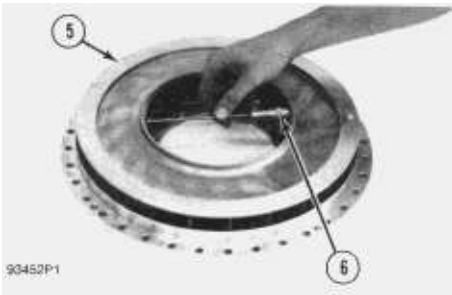

b. Use an inside diameter micrometer (6), and make a measurement of the inside diameter of outer edge of flange on impeller wheel (5) at four points. Make a record of the highest reading.

c. The clearance across the diameters between the impeller and stator is the difference between the highest reading on impeller and the lowest reading on stator. The clearance must be **0.25 to 0.35 mm (.010 to .014 in)**. Maximum permissible clearance across the diameters is **0.61 mm (.024 in)**.

d. The running clearance is one half of the measurement made across the diameters. Running clearance must be **0.125 to 0.175 mm (.005 to .007 in)**. Maximum permissible running clearance is **0.30 mm (.012 in)**.

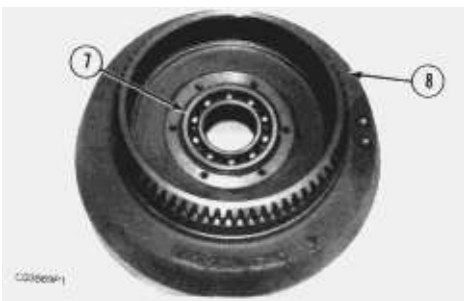

3. Use tooling (A), and install bearing (7) into housing (8).

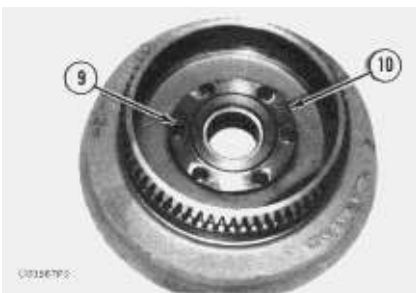

4. Put retainer (10) in position on the housing, and install six bolts (9). Tighten bolts (9) to a torque of **$50 \pm 7 \text{ N}\cdot\text{m}$ ($37 \pm 5 \text{ lb ft}$)**.

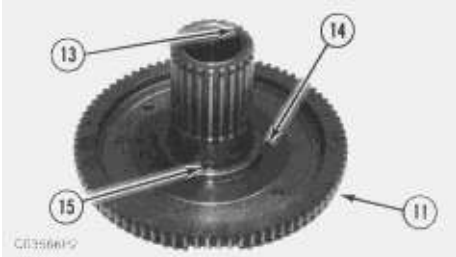
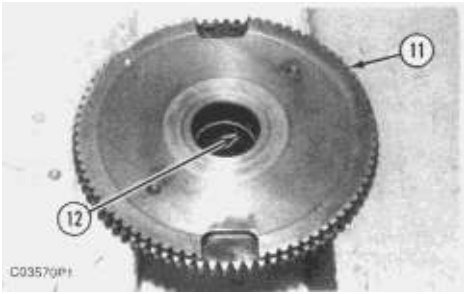

5. Use tooling (B), and install two bearings (12) and (13) in flange assembly (11).
 - a. Bearing (12) should be installed to a depth of 25.4 mm (1.0 in) below the surface of flange assembly (11).
 - b. Bearing (13) should be installed flush with the surface of flange assembly (11).
 - c. Bearings (12) and (13) should have an inside diameter of **44.501 ± 0.013 mm (1.7520 ± .0005 in)** after installation.
6. If carrier (14) was removed from flange assembly (11), heat the carrier to a temperature of **138° C to 166° C (280° F to 330° F)** for a maximum time of **ten minutes**. Install carrier (14) on flange assembly (11). Install seal ring (15) on the carrier.

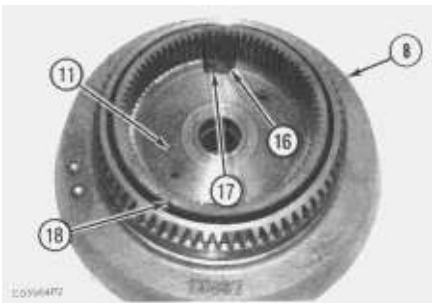

NOTICE

When the flange assembly is installed into the housing, use care to avoid causing damage to seal ring (15).

7. Put **SAE 30 oil** on seal ring (15). Pull the ends of the seal ring together, and install flange assembly (11) into housing (8).
8. Put retaining ring (17) in position in the groove on flange assembly (11). Compress the ring, and install gear (18). Make sure retaining ring (17) engages the slot in gear (18) to hold it into position.

9. Install two pins (16) to hold the retaining ring in position.

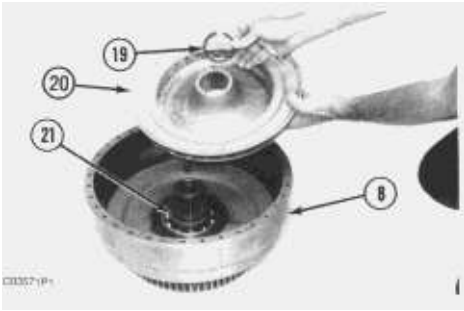

10. Hold gear (18) and flange assembly (11) to prevent them from sliding, and turn housing (8) over. Put spacer (21) in position on the flange assembly.

11. Install turbine wheel (20) onto the flange assembly.

12. Use tool (C), and install retaining ring (19) onto the flange assembly.

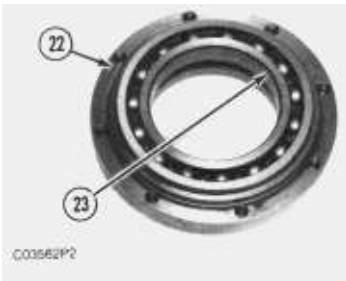

13. Use tooling (A), and install bearing (23) into carrier (22).

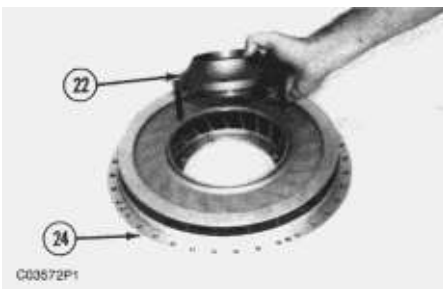

14. Use two 3/8 " - 24 NF **guide bolts**, and put carrier (22) in position in impeller wheel (24). Use tooling (A), and install carrier.

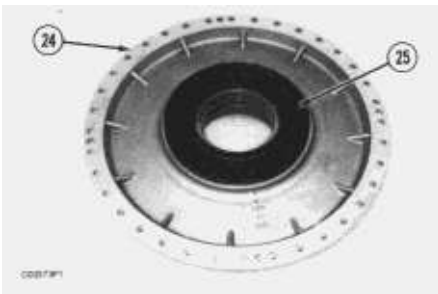

15. Turn impeller wheel (24) over, and put the retainer in position. Install eight bolts (25), and tighten to a torque of $50 \pm 7 \text{ N}\cdot\text{m}$ ($37 \pm 5 \text{ lb ft}$).

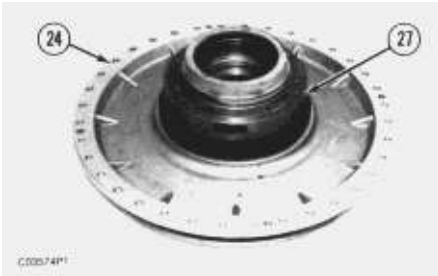
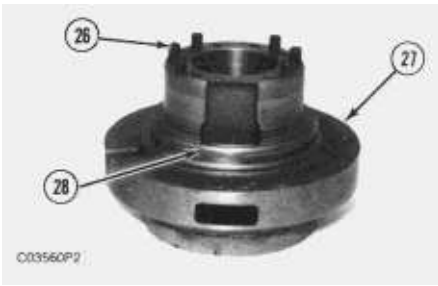

16. Install six pins (26) into carrier (27).

17. Install seal ring (28) onto the carrier.

NOTICE

When the carrier is installed into the impeller wheel, use care to avoid causing damage to seal ring (28).

18. Put **SAE 30 oil** on seal ring (28). Pull the ends of the seal ring together, and put carrier (27) into position on the impeller wheel.

19. Use tooling (A), and install carrier (27) into impeller wheel (24).



20. Turn the impeller wheel over, and install two 3/8" guide bolts. Put stator (29) in position, and install the eight bolts. Tighten the eight bolts evenly to a torque of **$30 \pm 5 \text{ N}\cdot\text{m}$ ($22 \pm 4 \text{ lb ft}$)**.



21. Turn the impeller wheel over. Install tooling (E) onto impeller wheel (24) and the carrier, and attach a hoist. Put the impeller wheel and carrier in position on housing (8). Remove tooling (E), and install the thirty-six bolts. Tighten the thirty-six bolts to a torque of **30 ± 5 N·m (22 ± 4 lb ft)**.

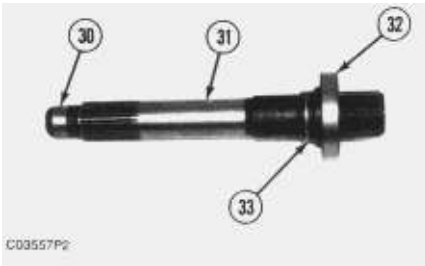

22. Heat race (30) to a temperature of **135° C (275° F)** for a maximum time of ten minutes, and install the race onto shaft assembly (31).

23. Install seal ring (33) onto the shaft assembly.

24. Heat bearing (32) to a temperature of **135° C (275° F)** for a maximum time of ten minutes. Install bearing (32) onto the shaft assembly.

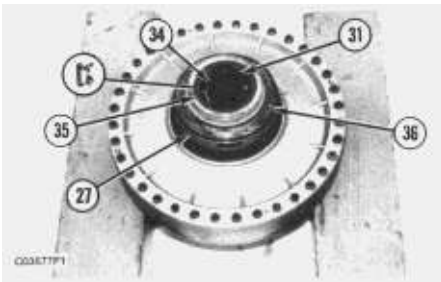

NOTICE

When the shaft assembly is installed into the converter group, use care to avoid causing damage to seal ring (33).

25. Put **SAE 30 oil** on seal ring (33). Pull the ends of the seal ring together, and install shaft assembly (31) and the bearing into the converter group.

26. Use tool (F), and install retaining ring (34).

27. Install O-ring seal (36) onto carrier (27). Put **SAE 30 oil** on the seal.

28. Install lip-type seal (35) into the carrier with the lip of the seal toward the bearing. Put **SAE 30 oil** on the lip of the seal.

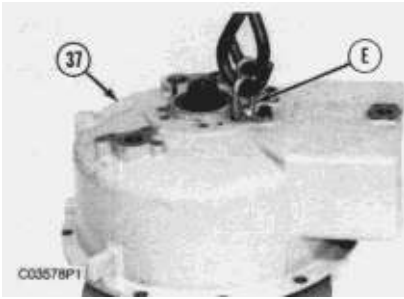

29. Install tooling (E) onto cover (37), and attach a hoist.

30. Use two 3/8 " - 24 NF guide bolts, and install cover (37) onto the converter group. Make sure O-ring seal (36) stays in position when the cover is installed.

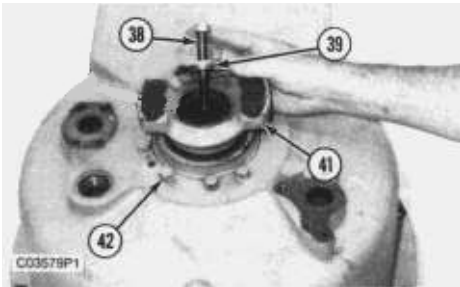

31. Install eight bolts (42), and tighten to a torque of $54 \pm 3 \text{ N}\cdot\text{m}$ ($40 \pm 2 \text{ lb ft}$).

32. Install yoke (41). Install retainer (39) and bolt (38). Tighten bolt (38) to a torque of $47 \pm 9 \text{ N}\cdot\text{m}$ ($34 \pm 6 \text{ lb ft}$).

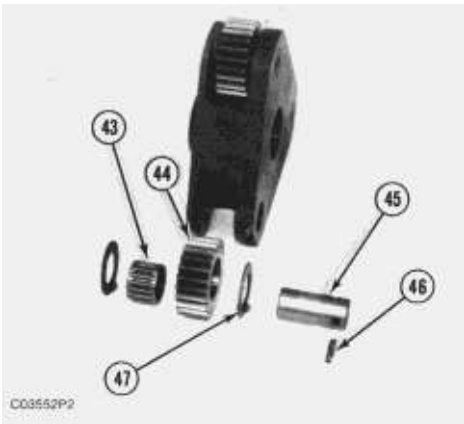

33. Put bearing (43) in gear (44). Put gear (44) and one disc (47) on each side of the gear in position in the carrier, and install shaft (45).

34. Align the hole in shaft (45) with the hole in the carrier, and install pin (46) flush with the surface of the carrier.

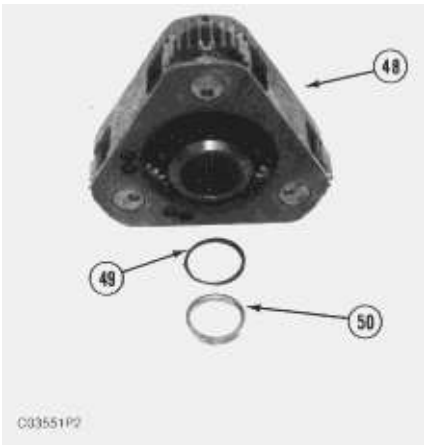

35. Install spiral ring (49) into the inner diameter of carrier (48). Put retainer (50) in position next to the spiral ring.

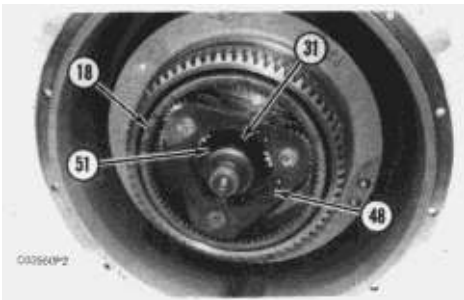

36. Put planetary carrier (48) with gears in position in gear (18) and on shaft assembly (31). Make sure retainer (50) stays in position.

37. Use tool (G), and install retaining ring (51).

End By:

a. install torque divider

Product: TRACK-TYPE TRACTOR

Model: D6H XR TRACK-TYPE TRACTOR 5KK

Configuration: D6H XR SERIES II TRACK-TYPE TRACTOR / POWER SHIFT / 5KK00001-UP (MACHINE) POWERED BY 3306 ENGINE

Disassembly and Assembly D6H TRACTOR POWER TRAIN

Media Number -SEN3242-03

Publication Date -01/11/2004

Date Updated -10/01/2017

SEN32420028

Clutch (Direct Drive)

SMCS - 3052-016; 3052-010; 3052-015

Remove And Install Clutch (Direct Drive)

Tools Needed		A
FT1897	Adapter	1
5P9736	Link Bracket	1
0S1595	Bolt	1
1D4719	Nut	1
0S1594	Bolt	1

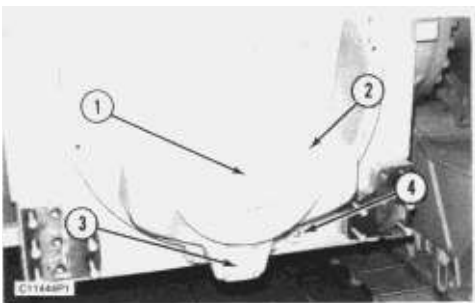

1. Remove plug (4) and drain approximately 129 liters (33.5 U.S. gal.) of power train oil. Install the plug.
2. Loosen the four bolts that hold magnetic cover (3) to the transmission cover, and drain the remainder of the transmission oil. Tighten the four bolts that hold cover (3).
3. Remove the six bolts, cover (1) and gasket from clutch (2).

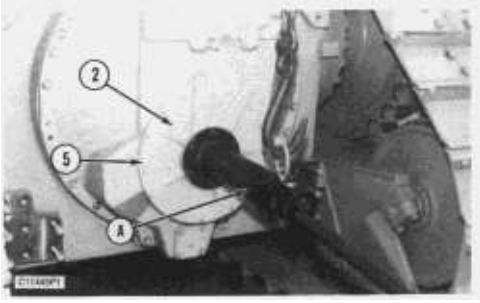

4. Install tooling (A) and attach a hoist. Put a bar into tooling (A) to counter balance clutch (2) when it is removed.

5. The weight of clutch (2) is **82 kg (181 lb)**. Remove bolts (5) that hold the clutch to the transmission cover. Use tooling (A) and remove clutch (2) from the transmission.



6. Remove two O-ring seals (6) and orifice (7) from the transmission cover.

NOTE: The following steps are for installation of the clutch.

7. Put orifice (7) and two O-ring seals (6) in position on the transmission cover.

8. Use tooling (A) and install clutch (2) onto the transmission. Make sure the input and output splines are aligned with the splines in the clutch.

9. Install bolts (5) that hold clutch (2) to the transmission cover.

10. Remove tooling (A). Put the gasket and cover (1) in position and install the six bolts that hold them.

11. Fill the power train system with oil. See The Operation And Maintenance Guide for the type of oil and capacity.

Disassemble Clutch (Direct Drive)

Tools Needed		A	B	C
5P5197	Snap Ring Pliers	1		
6V3010	Puller Group		1	
1P510	Driver Group		1	
0S1590	Bolt (3/8" - 16 x 2")		2	
5M2894	Washer (3/8")		2	
5P8245	Washer (1/2")		2	
5P4758	Snap Ring Pliers			1

Start By:

a. remove clutch

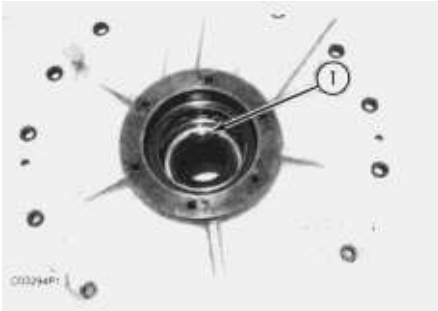

1. Use tool (A), and remove retaining ring (1).

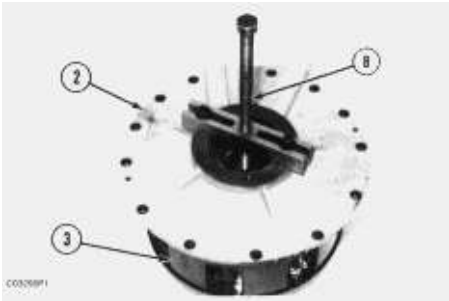

2. The weight of manifold assembly (2) is **75 kg (55 lb)**. The weight of housing assembly (3) is **170 kg (125 lb)**. Put tooling (B) in position as shown, and separate manifold assembly (2) from housing assembly (3).



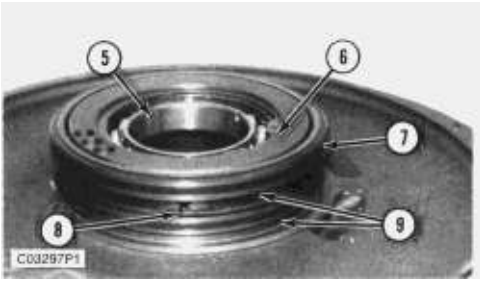

3. Remove O-ring seal (4) from manifold assembly (2).
4. Remove two seal rings (9) from the manifold assembly.
5. Remove retaining ring (6) and bearing (5) from manifold assembly (2).

NOTICE

Pin (8) and seal carrier (7) will be destroyed when removed from the manifold assembly.

6. If necessary, remove pin (8) and seal carrier (7) from manifold assembly (2).

NOTE: Manifold assembly (2) has an expanded tube in the inner diameter to block off internal oil passages. Although it resembles a bearing, it is not, and should be evaluated on the basis of surface condition.

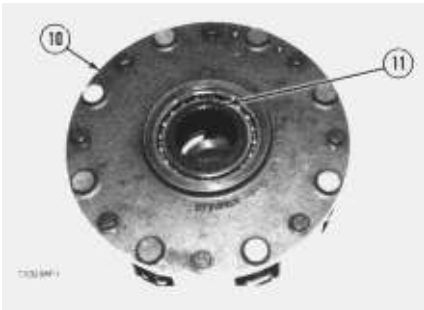

7. Use tool (A), and remove external retaining ring (11) from clutch housing (3).
8. Remove the eight bolts, and remove plate (10) from the clutch housing.

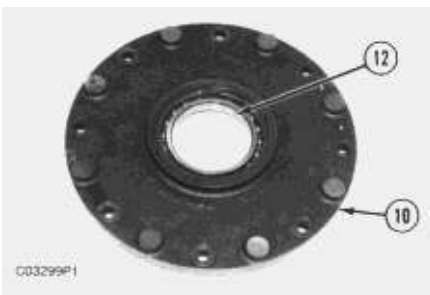

9. Use tool (C), and remove the retaining ring and bearing (12) from plate (10).

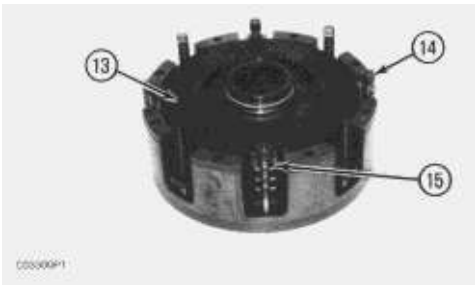

10. Remove four tubes (14).

11. Remove four disc assemblies (13), three plates (15) and the sixteen springs that go between the disc assemblies.

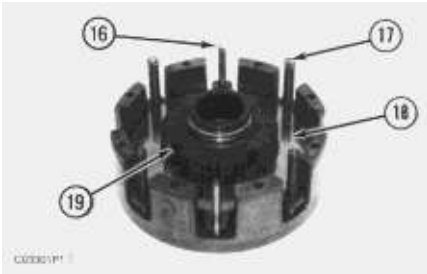

12. Remove four springs (17) and eight dowels (16) from the clutch housing.

13. Remove hub (19) and piston (18) from the clutch housing assembly.

14. Remove the O-ring seal from hub (19).

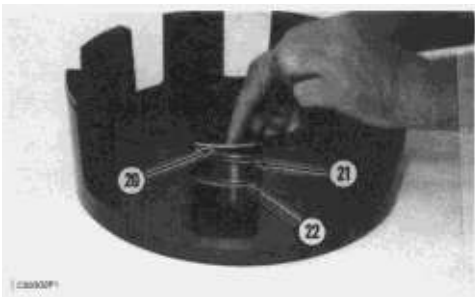

15. Remove ring (20) and O-ring seal (21) from the top groove of the clutch housing.

16. Remove ring (22) from the bottom groove of the clutch housing.



17. Turn the clutch housing over, and remove O-ring seal (23).

Assemble Clutch (Direct Drive)

Tools Needed		A	B
5P5197	Snap Ring Pliers	1	
5P5198	Snap Ring Pliers		1

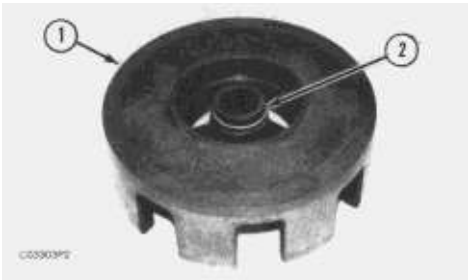

1. Put **SAE 30 oil** on O-ring seal (2) and in the groove in clutch housing (1). Install O-ring seal (2).

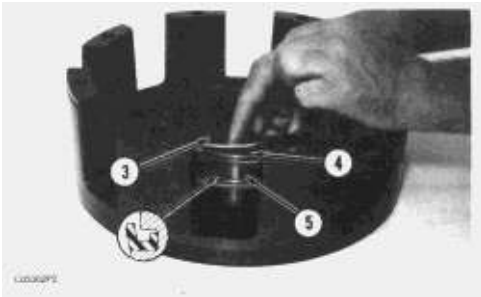

2. Turn the clutch housing over, and put **SAE 30 oil** on ring (5). Install ring (5) into the bottom groove of the clutch housing with the lip of ring (5) up as shown.

3. Put **SAE 30 oil** on O-ring seal (4) and ring (3). Install O-ring seal (4) into the top groove of the clutch housing. Install ring (3) into the top groove of the clutch housing. Ring (3) will be around the outer diameter of O-ring seal (4) when it has been installed correctly.

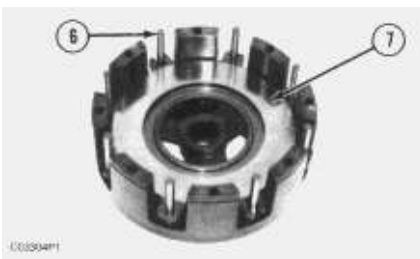

4. Install eight dowels (6) and piston (7) into the clutch housing.

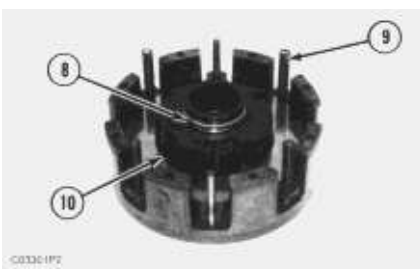

5. Install four springs (9).

6. Put hub (10) into position in clutch housing. Put **SAE 30 oil** on O-ring seal (8) and in the groove on hub (10). Install O-ring seal (8).

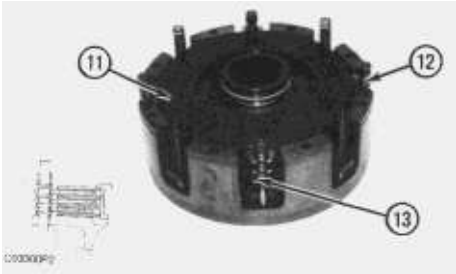

NOTE: A disc assembly has friction material on both sides. A plate is smooth and does not have friction material on either side. Put clean oil on all disc assemblies and plates before assembly.

7. Install four disc assemblies (11) and the three plates in the clutch housing. Start and stop with a disc assembly. Install sixteen springs (13) on both sides of the three plates.

8. Install four tubes (12).

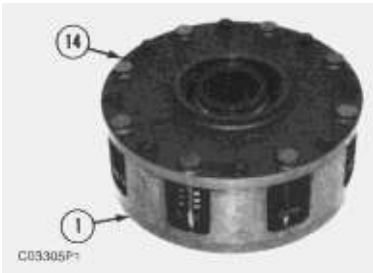

9. Align the splines on hub (10) with the disc assemblies, and put plate (14) in position. Install the eight bolts that hold plate (14) to clutch housing (1).

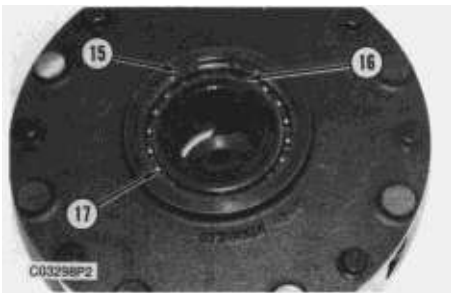

10. Lubricate the O-ring seal on hub (10) with **SAE 30 oil**, and install bearing (17).

11. Use tool (A), and install external retaining ring (16).

12. Use tool (B), and install internal retaining ring (15).

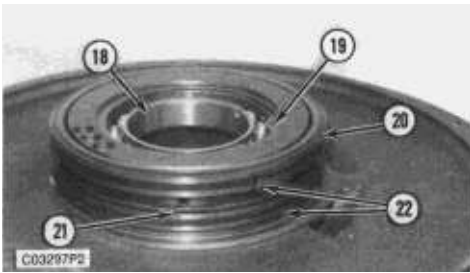

13. Install bearing (18) into manifold assembly (23). Use tool (B), and install retaining ring (19).

14. If it is necessary to install seal carrier (20) onto manifold assembly, use the following steps:

a. Heat seal carrier to **120° C to 165° C (248° F to 329° F)** for a maximum of **10 minutes**.

b. While the seal carrier is hot, align the pin hole in seal carrier (29) with the hole in the manifold assembly. Install seal carrier (20) onto manifold assembly (23) with the part number visible.

c. Install pin (21).

15. Install two seal rings (22).

16. Install O-ring seal (24) onto manifold assembly (23).

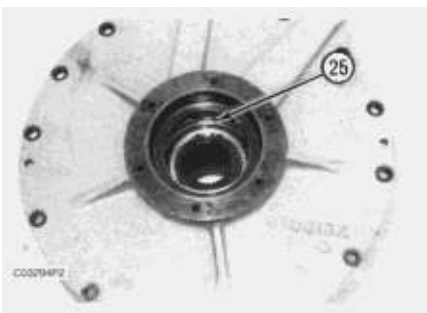

17. Put **SAE 30 oil** on the O-ring seal on the hub, and install manifold assembly (23) onto the clutch housing. Use tool (A), and install retaining ring (25).

End By:

a. install clutch

Product: TRACK-TYPE TRACTOR

Model: D6H XR TRACK-TYPE TRACTOR 5KK

Configuration: D6H XR SERIES II TRACK-TYPE TRACTOR / POWER SHIFT / 5KK00001-UP (MACHINE) POWERED BY 3306 ENGINE

Disassembly and Assembly D6H TRACTOR POWER TRAIN

Media Number -SEN3242-03

Publication Date -01/11/2004

Date Updated -10/01/2017

SEN32420029

Transmission Brake (Direct Drive)

SMCS - 3410-010; 3410-017

Remove And Install Transmission Brake (Direct Drive)

Start By:

- a. remove clutch

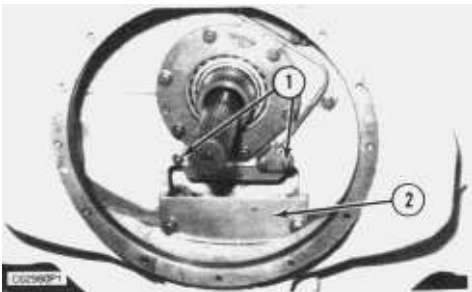

1. Remove the two bolts and baffle (2).
2. Remove two bolts (1) and the transmission brake.
3. To install the brake, put it into position, and install two bolts (1). Put baffle (2) in position, and install the two bolts that hold it.

End By:

- a. install clutch

Disassemble And Assemble Transmission Brake (Direct Drive)

Start By:

- a. remove transmission brake

Thank you so much for reading.
Please click the “Buy Now!”
button below to download the
complete manual.



After you pay.

You can download the most
perfect and complete manual in
the world immediately.

Our support email:

ebooklibonline@outlook.com