

Product: TRACK-TYPE TRACTOR

Model: D6H TRACK-TYPE TRACTOR 2KD

Configuration: D6H & D6H LGP SERIES II TRACTORS / POWERSHIFT / 2KD04033-UP (MACHINE) POWERED BY 3306 ENGINE

Disassembly and Assembly D6H TRACTOR POWER TRAIN

Media Number -SEN3242-03

Publication Date -01/11/2004

Date Updated -10/01/2017

SEN32420013

Final Drives

SMCS - 4050-012; 4050-015; 4050-016; 4050-011

Remove Final Drives

Tools Needed		A	B
FT1952	Axle Removal Tool	1	
8T3207	Lifting Bracket		1
5P8622	Shackle		1
1D4615	Bolt		2
1B4331	Nut		2
5P8248	Washer		4

Start By:

- a. separate track

NOTE: The final drive planetary carriers can be removed in chassis. See topic, Remove Final Drive Planetary Carriers (In Chassis).

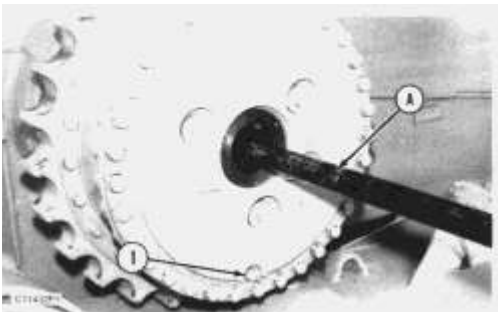

1. Turn the final drive until drain plug (1) is on the bottom as shown. Remove drain plug (1) and drain approximately **13.2 liters (3.4 U.S. gal.)** of oil from the final drive.

2. Remove the cover from the final drive and remove the O-ring seal from the cover.
3. Install tooling (A) and remove the outer axle.

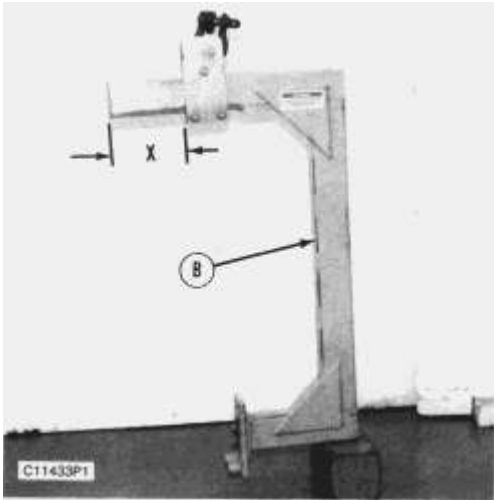

4. Adjust the top bracket on tooling (B) so that dimension (X) is **213 mm (8.4 in)**. The lower mounting bracket must be installed with the spacers outward as shown.

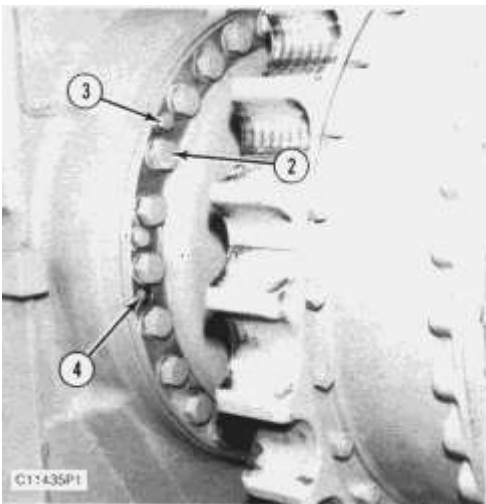
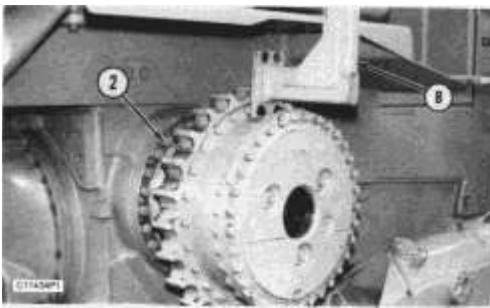

5. Remove two of the bolts from the sprocket segments. Fasten a hoist and install tooling (B) onto the final drive.

NOTICE

**Bolts (4) hold the steering clutch and brake to the main case and frame.
Do not remove bolts (4).**

6. Remove bolts (2) that hold the final drive to the main case and frame.
7. The weight of the final drive is **490 kg (1075 lb)**. Remove four bolts (3) that hold the final drive and steering clutch and brake together.
8. Use tooling (B) and remove the final drive from the machine.
9. Remove the O-ring seal from either the face of the steering clutch or the final drive hub.

Install Final Drives

Tools Needed		A	B
FT1952	Axle Removal Tool	1	
8T3207	Lifting Bracket		1
5P8622	Shackle		1
1D4615	Bolt		2
1B4331	Nut		2
5P8248	Washer		4

1. Inspect the condition of O-ring seals and replace if necessary.
2. Put the O-ring seal in position on the face of the steering clutch.

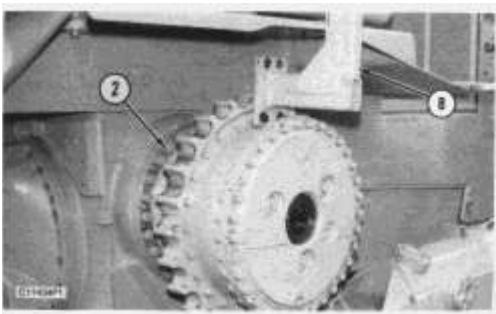

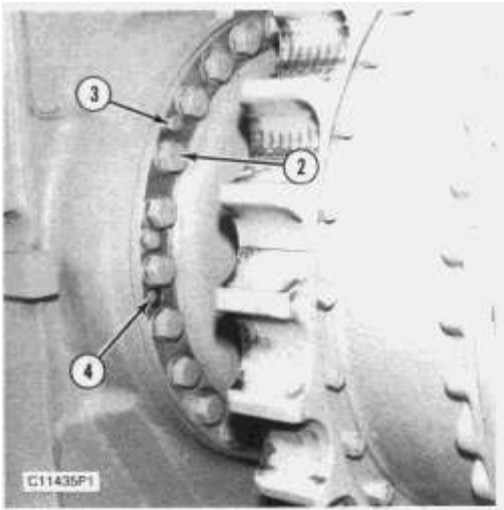

3. Fasten a hoist and install tooling (B) onto the final drive. Adjust tooling (B) if necessary to put the final drive in a level position.
4. Put the final drive in position onto the frame and install four bolts (3) that hold the final drive to the steering clutch and brake.
5. Install bolts (2) that hold the final drive and steering clutch and brake to the main case and frame. Remove tooling (B).
6. Put **SAE 30 oil** on the threads of the segment bolts. Install the bolts and nuts with the nuts and washers against the final drive. Tighten the nuts to a torque of **175 ± 40 N·m (130 ± 30 lb ft)**. Tighten the nuts **1/3 of a turn more**.

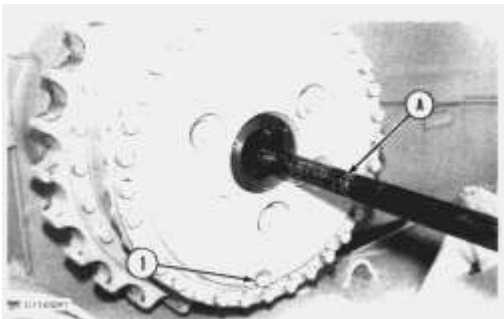

7. Install tool (A) onto the outer axle and install the axle into the final drive.
8. Install the O-ring seal onto the cover and install the cover onto the final drive.
9. Rotate the final drive so drain plug (1) is toward the bottom. Fill the final drive with oil to the bottom of the fill plug hole. See the Operation And Maintenance Guide for the type of oil and capacity.

End By:

- a. connect track

Disassemble Final Drives

Tools Needed		A	B	C	D
6V2156	Link Bracket	3			
1A2029	Bolt	3			
1P510	Driver Group		1		
FT1934	Beam			1	
6V3160	Cylinder			1	
6V9061	Pump Group			1	
1D4621	Bolt			4	
6V2157	Link Bracket				2
2A1538	Bolt				2

Start By:

a. remove final drives

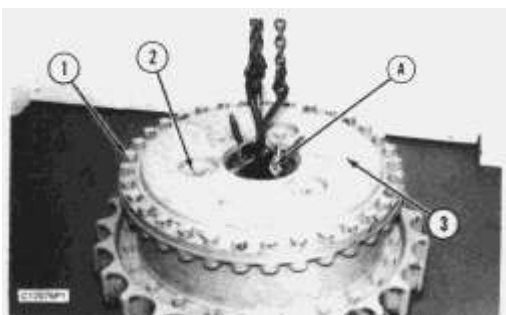

1. Install tooling (A) onto the planetary carrier and attach a hoist.
2. The weight of the planetary carrier is **137 kg (301 lb)**. Remove bolts (1) that hold the planetary carrier to the hub. Remove planetary carrier (3) and the two O-ring seals from the hub.
3. Remove three retainers (2).

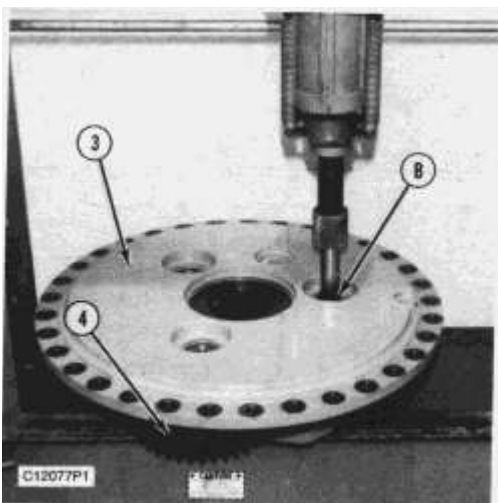

4. Support planetary carrier (3), from underneath, to prevent damage. Use tooling (B) and a press and remove the three planetary gear shafts.

5. Remove three planetary gears (4) from carrier (3).



6. Remove bearing cones (5) from each of the gears (4).

7. Remove the bearing cups from each side of the gears.

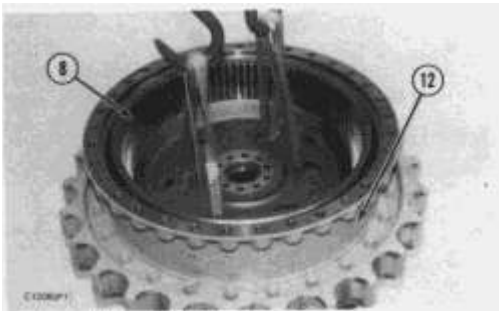
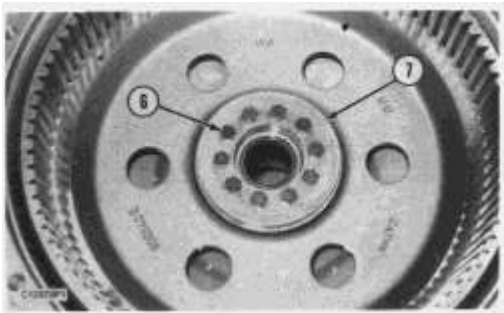

8. Remove ten bolts (6) and retainer (7).

9. The weight of the hub and ring gear (8) is **68 kg (150 lb)**. Use nylon straps and a hoist and remove the hub and ring gear (8).

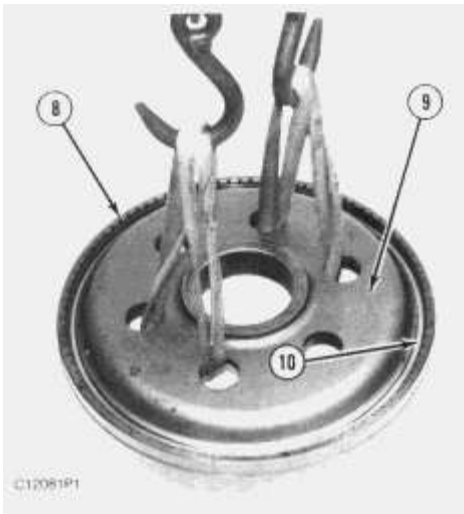

10. Turn hub (9) and ring gear (8) over. Remove retaining ring (10). The weight of hub (9) is **37 kg (82 lb)**. The weight of ring gear (8) is **32 kg (71 lb)**. Use nylon straps and a hoist and remove hub (9).

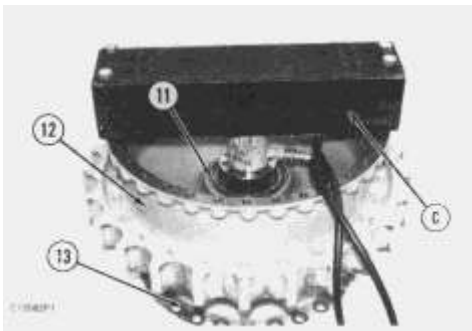

11. Install tooling (C) onto hub (12).

NOTICE

Do not lift hub (12) high enough to make contact with the fitting on the hydraulic cylinder, [part of tooling (C)].

12. Use tooling (C) and loose hub (12) from spindle (13). Remove tooling (C).

13. Remove bearing cone (11).

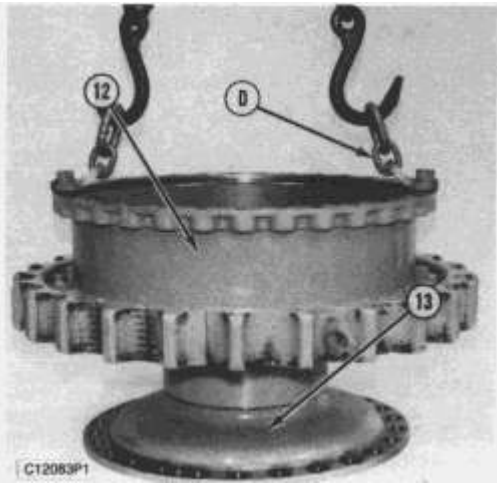

14. The weight of hub (12) is **180 kg (395 lb)**. Install tooling (D) and attach a hoist. Remove hub (12) from spindle (13).

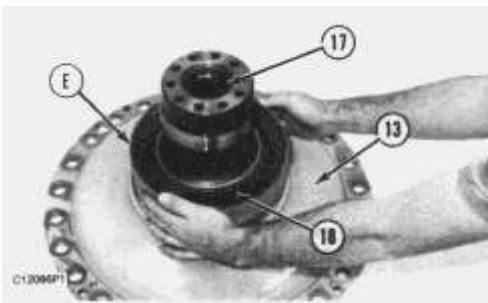

15. Turn hub (12) over and remove Duo-Cone Seal (15). Use a hammer and a punch and remove bearing cup (16).

16. Turn the hub over and remove bearing cup (14) from the hub.

NOTE: If the Duo-Cone Seals are to be used again, put identification marks on the seals so they can be assembled and installed in their original position.

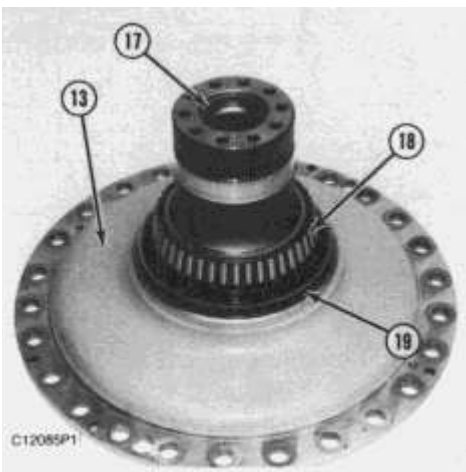

NOTICE

Bearing cone (18) may be damaged if it is removed from spindle (13).

17. Remove Duo-Cone Seal (19) from spindle (13).
18. If necessary, remove bearing cone (18) from the spindle.
19. Remove lip-type seal (17) from spindle (13).

Assemble Final Drives

Tools Needed		A	B	C	D	E
6V2156	Link Bracket	3				
1A2029	Bolt	3				
1P510	Driver Group		1			
6V2157	Link Bracket				2	
2A1538	Bolt				2	
8M9395	Installer					1

1. Put clean oil on all of the parts during assembly.

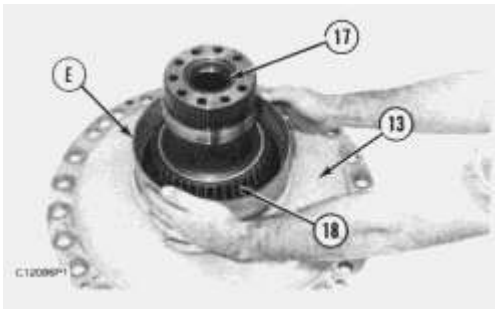

2. Use tooling (B) and install lip-type seal (17) into spindle (13). Put clean oil on the lip of the seal.
3. Heat bearing cone (18) to a maximum temperature of **135° C (275° F)**. Install bearing cone (18) onto spindle (13).

NOTE: Before installing any of the Duo-Cone Seals, see Installation Of the Duo-Cone Floating Seals in this module.

4. Use tool (E) and install the Duo-Cone Seal onto spindle (13).

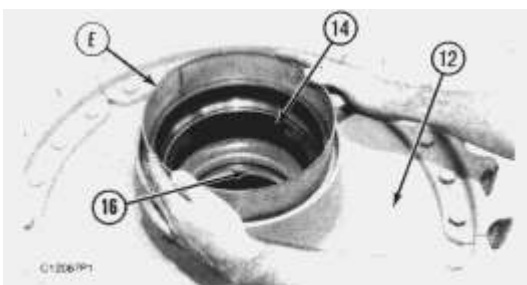

5. Lower the temperature of bearing cups (14) and (16) and install them into hub (12).

6. Use tool (E) and install the Duo-Cone Seal into hub (12).

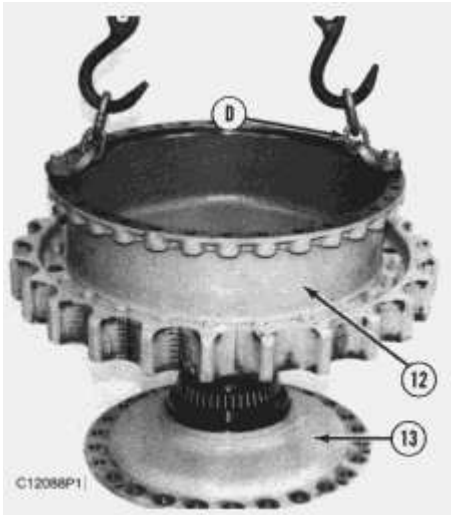

7. Install tooling (D) onto hub (12) and attach a hoist. Carefully, put hub (12) in position on spindle (13).

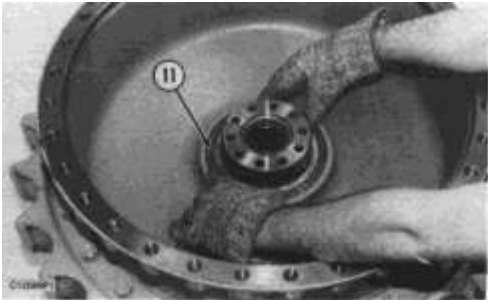

8. Heat bearing cone (11) to a maximum temperature of **135° C (275° F)**. Install bearing cone (11) onto spindle (13).



9. Use nylon straps and a hoist and put hub (9) in position in gear (8) and install retaining ring (10).

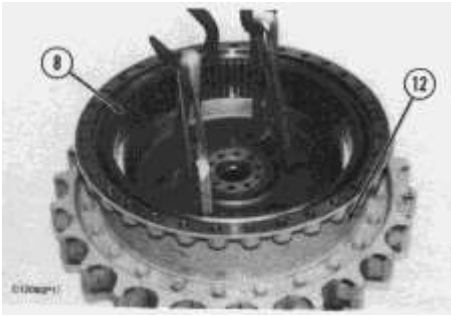

10. Turn the hub and gear (8) over and install nylon straps. Attach a hoist to the nylon straps and put the hub and the gear in position in hub (12).

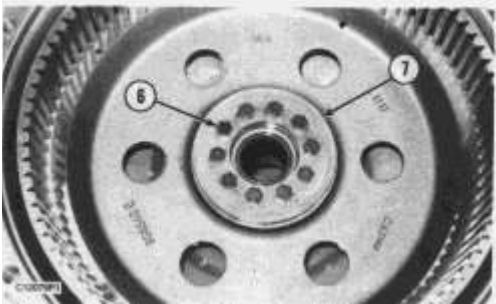

11. Put retainer (7) in position and install ten bolts (6), while slowly rotating the hub. Tighten bolts (6) evenly to a torque of $135 \pm 15 \text{ N}\cdot\text{m}$ ($100 \pm 11 \text{ lb ft}$). The retainer must be in contact with the end of spindle (13) after bolts (6) have been tightened.

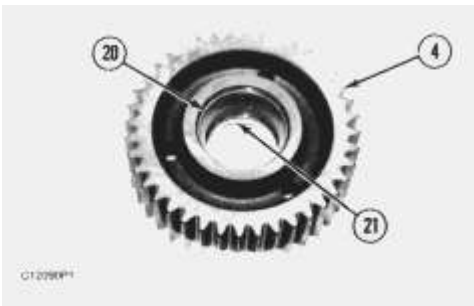

12. Lower the temperature of bearing cups (20) and (21) and install them into three planetary gears (4).

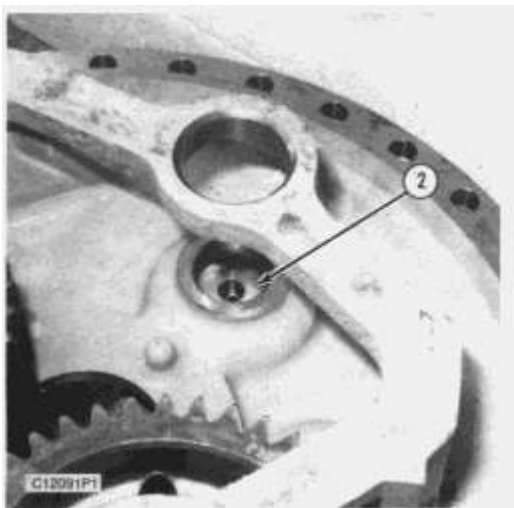

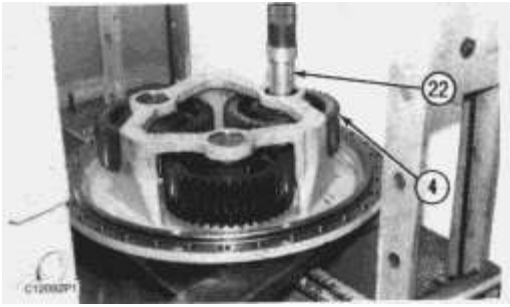

13. Put the planetary carrier in position in a press. Planetary shaft retainer (2) should be in position and supported so as to act as a positive stop for the shaft when it is installed.

NOTICE

Shaft (22) must be installed correctly or bearing preload will be incorrect and damage will result.

14. Put planetary gear (4) in position in the planetary carrier.

15. Lower the temperature of shaft (22) and use a press to install it into the planetary carrier. The end of shaft (22) must be installed flush with the retainer surface of the planetary carrier for correct bearing preload. Make sure the gear will rotate by hand after it has been installed. If it will not rotate by hand, the problem should be found and corrected. Repeat the procedure for three shafts.

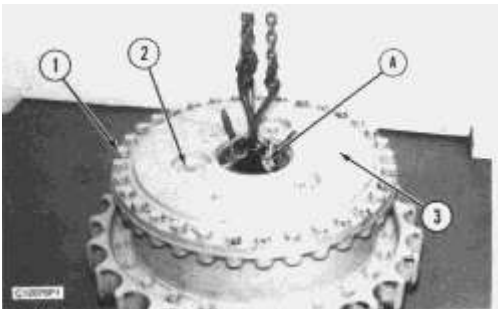

16. Install three retainers (2) on shafts (22).

17. Install tooling (A) and attach a hoist. Install the two O-ring seals onto the planetary carrier. Align the drain hole in the carrier with the drain hole in the hub.

18. Put the planetary carrier in position on the hub.

19. Install the bolts that hold the planetary carrier to the hub. Remove tooling (A).

Product: TRACK-TYPE TRACTOR

Model: D6H TRACK-TYPE TRACTOR 2KD

Configuration: D6H & D6H LGP SERIES II TRACTORS / POWERSHIFT / 2KD04033-UP (MACHINE) POWERED BY 3306 ENGINE

Disassembly and Assembly D6H TRACTOR POWER TRAIN

Media Number -SEN3242-03

Publication Date -01/11/2004

Date Updated -10/01/2017

SEN32420014

Final Drive, Steering Clutch And Brake

SMCS - 4050; 4100-029; 4100-011; 4100-012

Remove Final Drive, Steering Clutch And Brake

Tools Needed		A	B
FT1952	Axle Removal Tool	1	
8T3207	Lift Bracket		1
1A5405	Bolt (5/8" - 11 x 5" long)		2
1D4720	Nut (5/8" - 11)		2
5P8247	Washer (5/8")		4

Start By:

- a. separate track

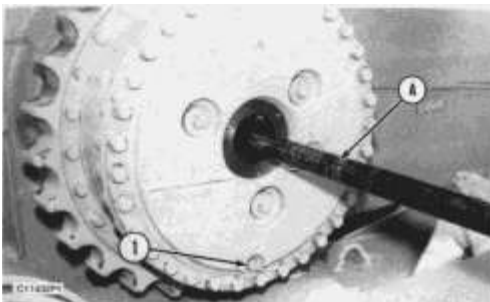

1. Turn the final drive until drain plug (1) is on the bottom as shown. Remove drain plug (1) and drain approximately **11.4 liters (3 U.S. gal.)** of oil from the final drive.
2. Remove the three bolts and the cover from the final drive. Remove the O-ring seal from the cover.
3. Use tool (A) and remove the outer axle shaft.

4. Use tool (A) and remove the inner axle shaft.

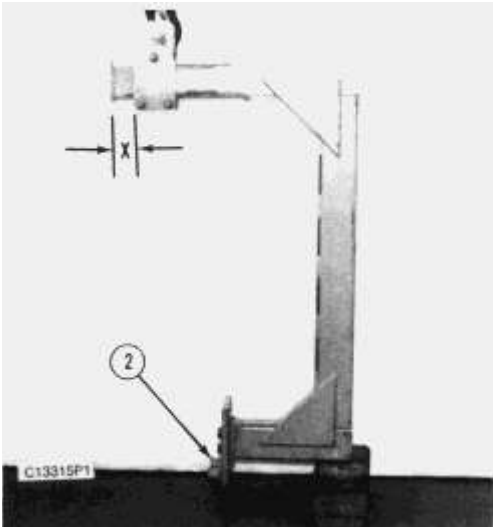

5. Adjust the lifting shackle on the 8T3207 Lift Bracket [part of tooling (B)] so distance (X) is **63.5 mm (2.5 in)**. The lower mounting bracket should be installed so spacers (2) will be against the sprocket.

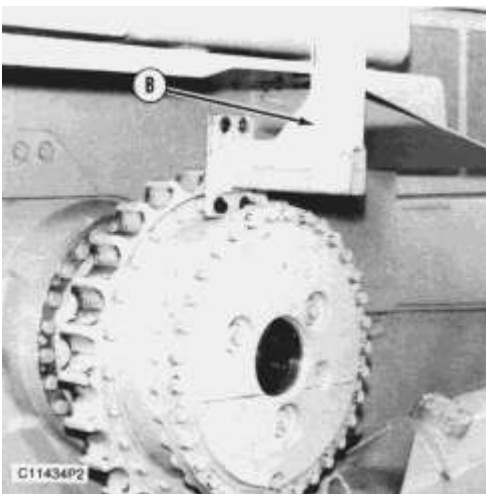

6. Remove two bolts from the sprocket segments. Fasten a hoist and install tooling (B) on the final drive as shown.

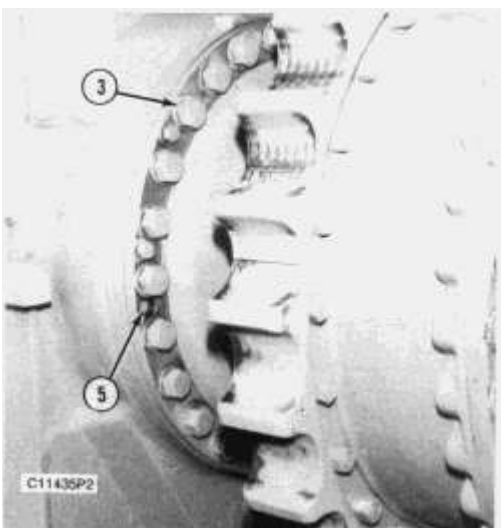

7. Remove 26 bolts (3) that hold the final drive and steering clutch and brake to the frame.

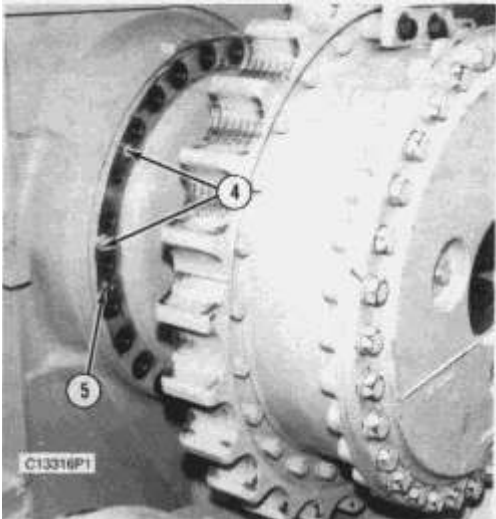

NOTICE

Do not remove four bolts (4) that hold the final drive to the steering clutch and brake.

8. The weight of the final drive and steering clutch and brake assembly is **682 kg (1500 lb)**. Remove two bolts (5) that hold the steering clutch and brake to the frame.

9. Use tooling (B) and a hoist and remove the final drive and steering clutch and brake as a unit.

Install Final Drive, Steering Clutch And Brake

Tools Needed		A	B
8T1952	Axle Removal Tool	1	
8T3207	Lift Bracket		1
1A5405	Bolt (5/8" - 11 x 5" long)		2
1D4720	Nut (5/8" - 11)		2
5P8247	Washer (5/8")		4

1. Inspect all O-ring seals for damage and replace if necessary.

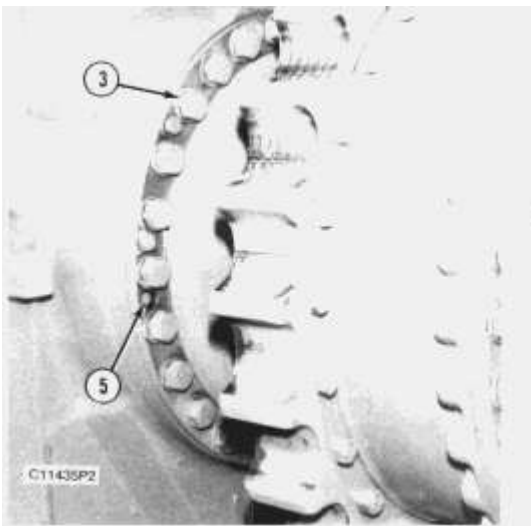
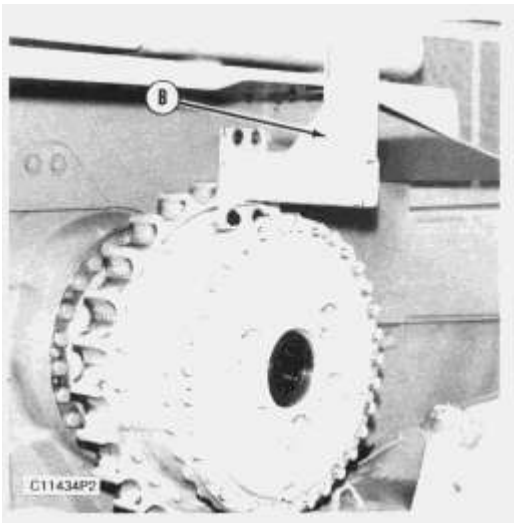

2. Fasten a hoist and install tooling (B) onto the final drive. Make an adjustment to tooling (B) if needed, to level the final drive and steering clutch and brake.
3. Put the final drive, steering clutch and brake in position on the tractor.
4. Install two bolts (5) that hold the steering clutch and brake.
5. Install 26 bolts (3) that hold the final drive, steering clutch and brake in position. Remove tooling (B).
6. Put **SAE 30 oil** on the threads of two segment bolts. Install so the head of the bolts are against the segment and so the washers and nuts are against the final drive.
7. Tighten the nuts to a torque of **$175 \pm 40 \text{ N}\cdot\text{m}$ ($130 \pm 30 \text{ lb ft}$)**. Tighten the nuts **1/3 of a turn more**.

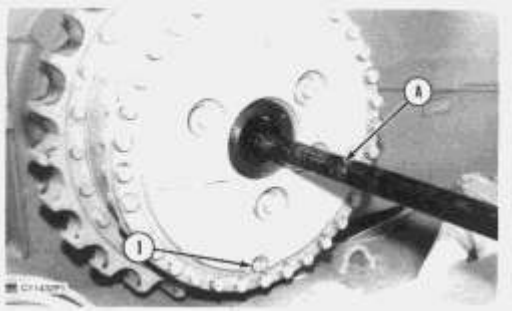

8. Use tool (A) and install the inner axle. Remove tool (A).
9. Use tool (A) and install the outer axle. Remove tool (A).
10. Put the O-ring seal in position on the cover and install the cover on the final drive.
11. Rotate the final drive so drain plug (1) is toward the bottom. Fill the final drive with oil to the bottom of the fill plug hole. See the Operation and Maintenance Guide for the correct type of oil and capacity.

End By:

- a. connect track

Seperate And Connect Final Drive, Steering Clutch And Brake

Tools Needed		A
5P9736	Link Bracket	2
0S1587	Bolt (1/2" - 13 x 1 3/4" long)	2

Start By:

- a. remove final drive, steering clutch and brake

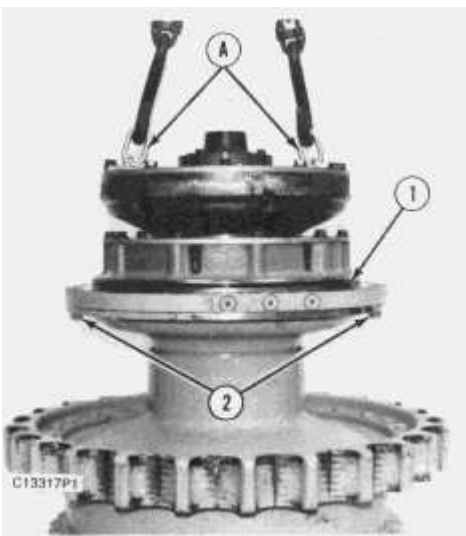

1. Remove O-ring seal (1).
2. The weight of the steering clutch and brake assembly is **255 kg (560 lb)**. Install tooling (A) and attach a hoist as shown.
3. Remove bolts (2).
4. Remove the steering clutch and brake from the final drive.



5. Turn the steering clutch and brake over and remove O-ring seal (3).

NOTE: The following Steps are for connection of the final drive and steering clutch and brake.

6. Inspect the O-ring seals for damage and replace if necessary. Put clean oil on the O-ring seals.
7. Put O-ring seal (3) in position on the steering clutch and brake.
8. Install tooling (A) and attach a hoist. Put the steering clutch and brake in position on the final drive.
9. Install bolts (2) that hold the steering clutch and brake to the final drive.
10. Put O-ring seal (1) in position on the steering clutch and brake.

End By:

- a. install final drive, steering clutch and brake.
-

Product: TRACK-TYPE TRACTOR

Model: D6H TRACK-TYPE TRACTOR 2KD

Configuration: D6H & D6H LGP SERIES II TRACTORS / POWERSHIFT / 2KD04033-UP (MACHINE) POWERED BY 3306 ENGINE

Disassembly and Assembly D6H TRACTOR POWER TRAIN

Media Number -SEN3242-03

Publication Date -01/11/2004

Date Updated -10/01/2017

SEN32420015

Steering Clutches and Brakes

SMCS - 4100-015; 4100-016

Disassemble Steering Clutches and Brakes

Tools Needed		A	B	C	D
5P9736	Link Bracket	3			
5P5197	Pliers		1		
1P7405	Forged Eyebolt, 3/8"			3	
1P520	Driver Group				1

Start By:

- a. separate final drive from steering clutch and brake

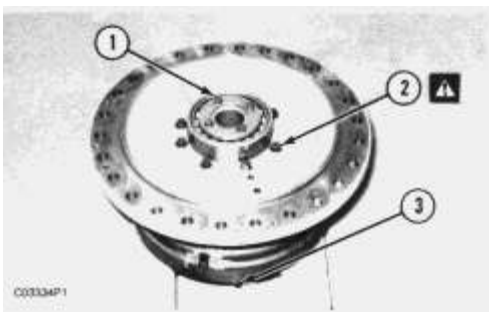

WARNING

The brake group contains springs that are under compression. To prevent possible personal injury from flying parts, the brake group must be disassembled exactly as the following steps describe. Do not remove bolts (2) until after bolts (3) are slowly loosened and removed.

1. Remove the four bolts and plate (1) from the steering clutch and brake assembly. Do not remove bolts (2) at this time.



2. Install tooling (A), and attach a hoist. The weight of brake group (4) is **159 kg (350 lb)**. Remove brake group (4) from steering clutch group (5).

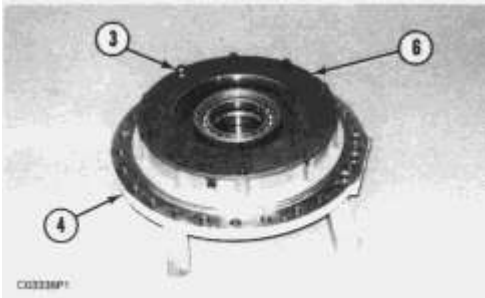

! WARNING

To prevent possible personal injury from flying parts, make sure bolts (2) are tight before bolts (3) are removed. Bolts (3) are long enough to release the spring pressure behind retainer (6) as long as bolts (2) are installed.

3. Turn brake group (4) over. Evenly loosen 10 bolts (3) to release the spring pressure behind retainer (6). Remove bolts (3) and retainer (6).

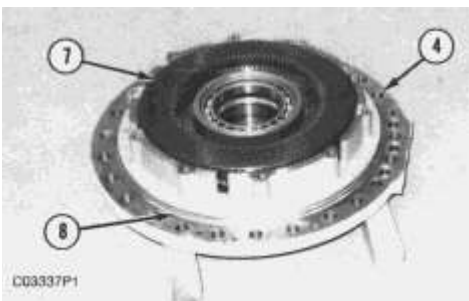

4. Remove four discs (7) and the three plates from brake housing (4).

5. Remove O-ring seal (8) from the brake group.

Thank you so much for reading.
Please click the “Buy Now!”
button below to download the
complete manual.



After you pay.

You can download the most
perfect and complete manual in
the world immediately.

Our support email:

ebooklibonline@outlook.com