



Engine

Removal



DANGER

1. Disconnect the lead from the battery negative terminal (-) and apply the parking brake.

Versions with cab.

Remove screws (1) and support (2).



- 2.

For all versions.

Position a stand "A" under the clutch housing.

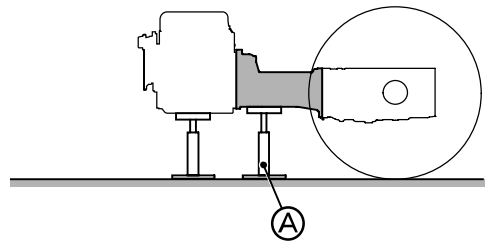

D0020730

- 3.

Remove nut (3) and disconnect the starter motor cable.



- 4.

Disconnect the brake pipes (4), remove nut (6) and remove the "Separate brakes" valve (5)



IMPORTANT

Plug the pipes to prevent the ingress of dirt.

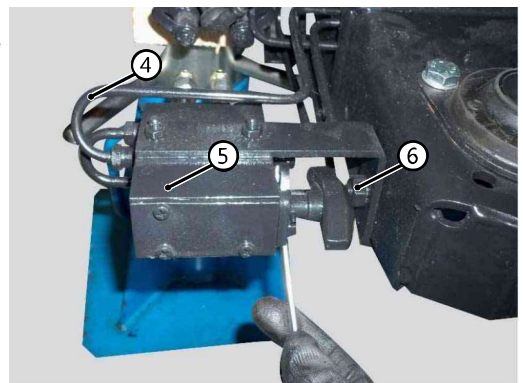

5.

Remove bracket (6) and disconnect front diff. lock pipe (7).



IMPORTANT

Plug the pipes to prevent the ingress of dirt.

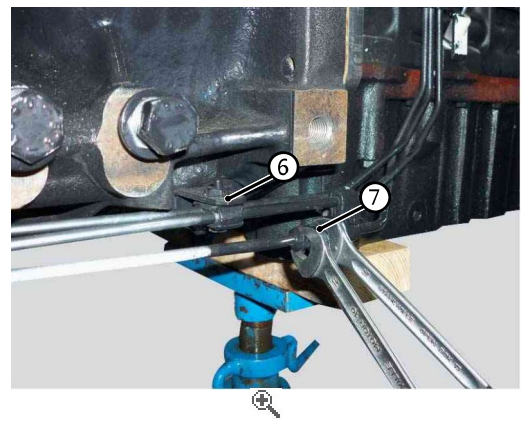

6.

Remove the screws (8) on the right-hand side.

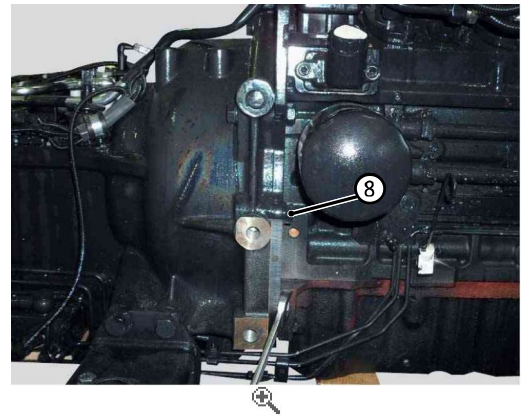

7.

Remove the screws (9) on the left-hand side.

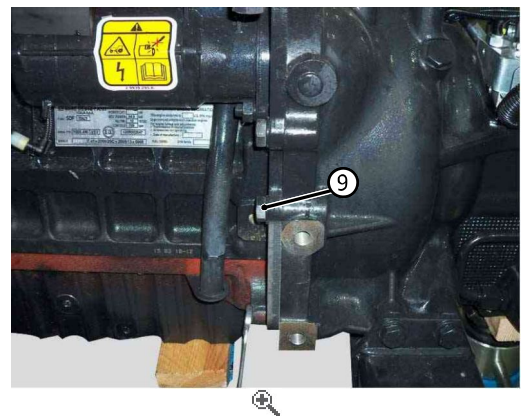

8.

Remove upper screws (10).

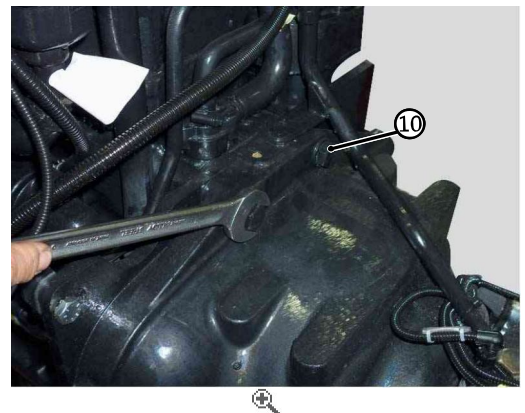

9.

Remove lower screws (11).

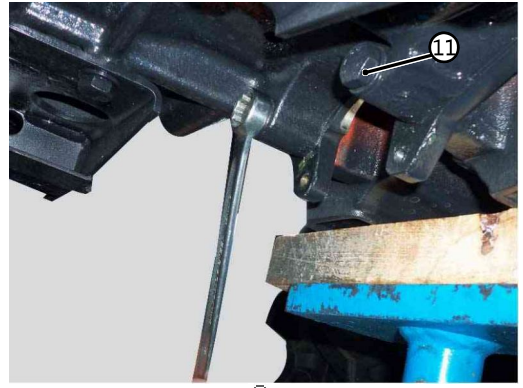

10.

Remove screws (12) on the pipe bracket.

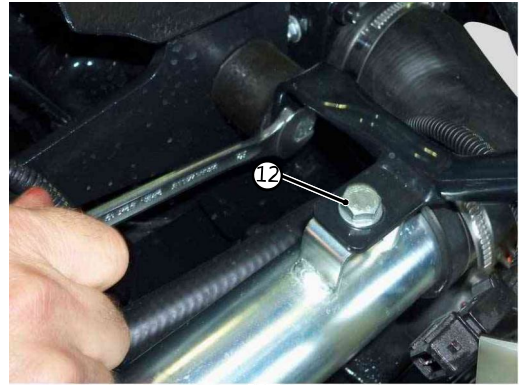

11.

Remove screws (13) from the plate.



12.

Remove the wiring earth (14), release the wiring (15).

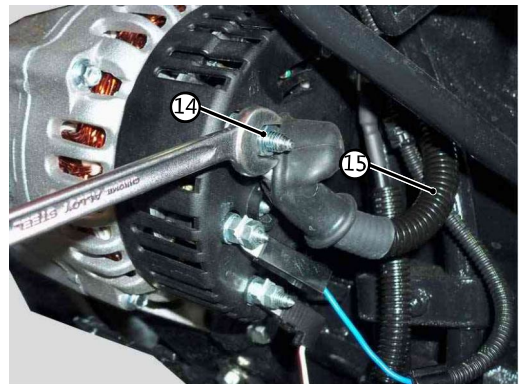

13.

Remove the silent block (16).

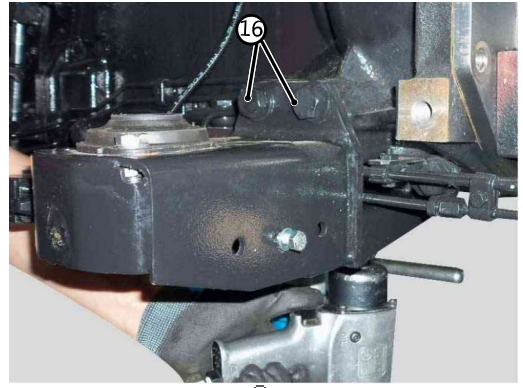

14.

Remove screws (17).

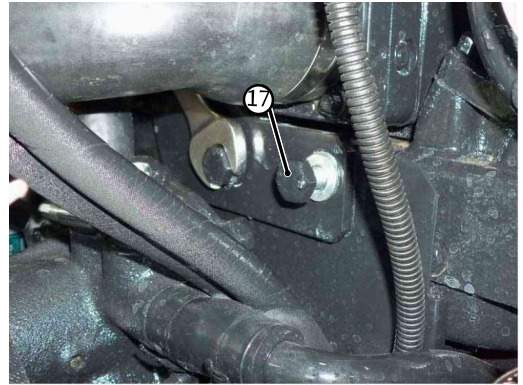

15.

Insert bracket (18).



16.

Remove hood support screws (19).

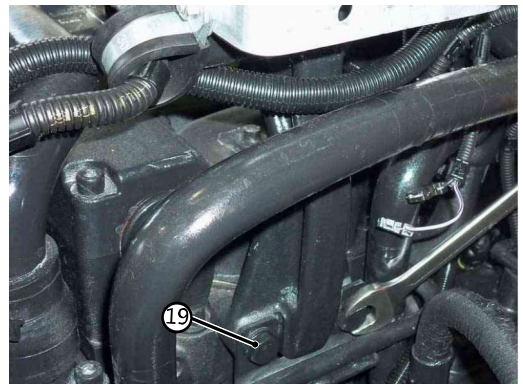

17.

Insert second bracket (20).

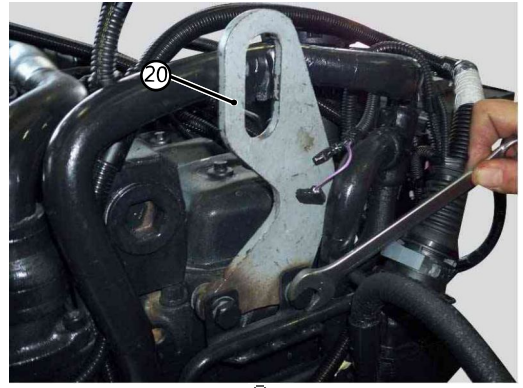

18.

Attach the engine to a suitable hoist (21).



19.

Separation of the engine



20.

Refitting

1. Refitting is the reverse of removal.
2.
 - o To facilitate installation of the shafts, turn the crankshaft slightly in both directions.
M12 screws: 70 ± 3.5 Nm (51.6 ± 2.6 lb.ft.)
M14 screws: 111.5 ± 6.5 Nm (81.8 ± 4.8 lb.ft.)
Nut: $16/20$ Nm ($11.8-14.8$ lb.ft.)



Operations prior to removal

1. During disassembly remove from the engine:

- o Disconnect the accelerator and engine stop cables of the mechanical governor, the fuel supply and return pipes;
- o starter motor;
- o cooling fan and relative belt;
- o alternator, oil filters and auxiliary PTO, if present;
- o air conditioning compressor, if present, and relative drivebelt;
- o trailer air braking compressor, if present;
- o clutch;
- o flywheel;
- o engine mounting flange.

Removal of blow-by assembly

DANGER



The blow-by unit is one of the solutions adopted; for other models the solution may be different, but the operations to be performed are identical.

Loosen the clamps and disconnect oil recovery pipes (15).

NOTE



Renew the oil seal on reassembly.

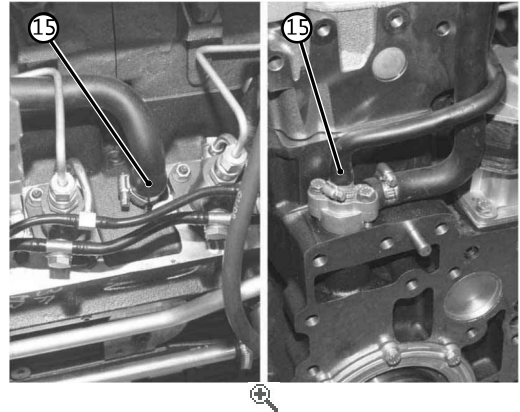

1.

Remove nuts (16) and remove blow-by assembly (17) complete with pipes.

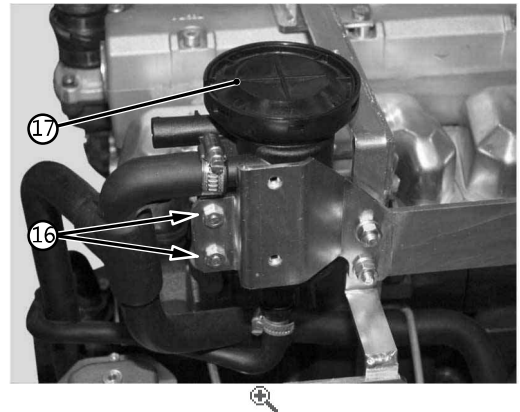

2.

Loosen screws with washer (18) and remove filler (19).

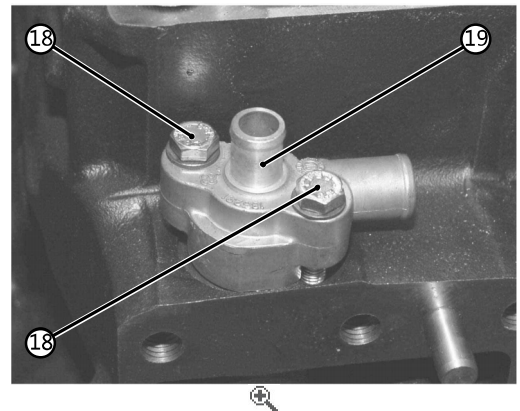

3.

Remove union (20).

NOTE



Renew oil seal (21) on reassembly.

4.

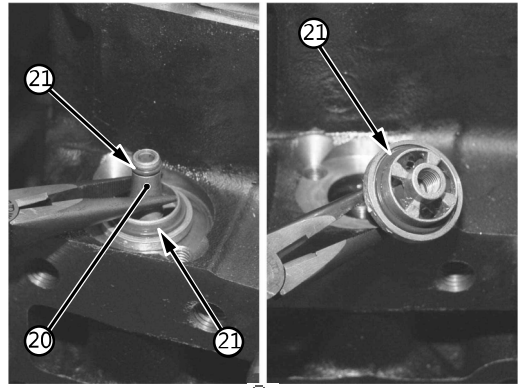

T.\$37.21.B0.00.00.00.01 - v1



Checking engine block

1. Mount main bearing caps complete with main bearing shells or main bearings on the block.



NOTE

Position the main bearing caps and main bearing shells according to the punched numbers and the marks executed on disassembly.

Fix the main bearing caps with the screws.

Screws: 92 Nm (67.8 lb.ft.)

Check the main bearings diameter and out of round with an internal dial gauge.



NOTE

Make a note of the values read for each main bearing and renew the bearing if the diameters exceed the tolerance limits specified in "TECHNICAL DATA AND DIMENSIONS".



NOTE

The main bearings must be replaced with undersize main bearings whenever the crankshaft is reground.

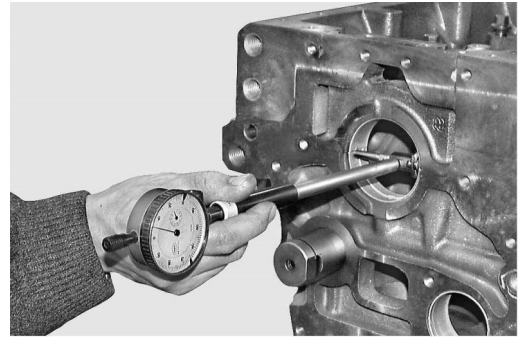

- 2.

Check the crankshaft main bearings diameter with an internal dial gauge.



NOTE

If the bearings exceed the permissible tolerance values specified in "TECHNICAL DATA AND DIMENSIONS" they must be replaced, and the new bearings must be bored after assembly.



NOTE

To facilitate removal of the worn main bearings and boring of the new main bearings, remove the plug on the flywheel side. When this procedure has been carried out, refit a new plug smeared with sealant.

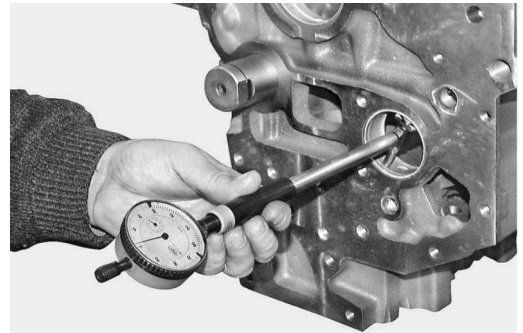

Plug: Loctite 554

- 3.



Crankshaft

Position a dial gauge on a magnetic stand "A" and preload the gauge by about 3 mm (0.118 in.) on the head of crankshaft (1). Using lever "B", pry the crankshaft axially in one of the two directions; set the dial gauge to zero and move the crankshaft in the opposite direction to check if the end float reading is within the permissible range of values. If the end float is not within the specified limits, replace the thrust washers with oversize versions (see "Technical data checks").

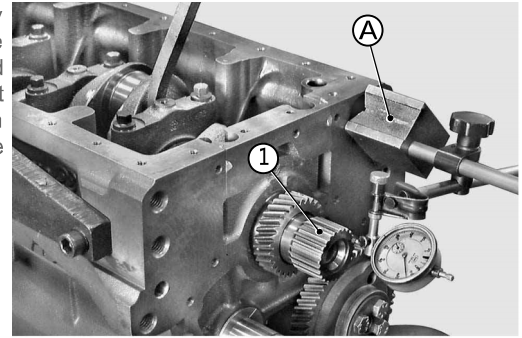

1.

Remove the screws and remove connecting rod caps (2) complete with main bearing shells (3).



NOTE

Label the main bearing shells and connecting rod for the following dimensional check.



NOTE

Note the connecting rod cap and relative connecting rod are marked with punched numbers facing the injection pumps side.



NOTE

Mark the assembly position of each connecting rod. Do not switch positions unless a general overhaul is to be carried out.

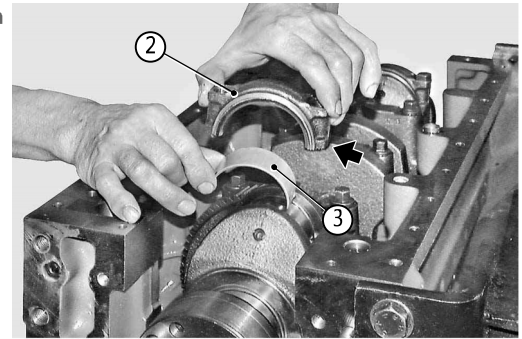

2.

Remove the screws and remove central main bearings (4) complete with the main bearing shells.



NOTE

Label the main bearing shells and main bearings for the following dimensional check.



NOTE

Note that the central main bearings have the same numerical punch marking shown on the engine block and that orientation is defined by the smaller diameter spot facings "A" facing the injection pump side.

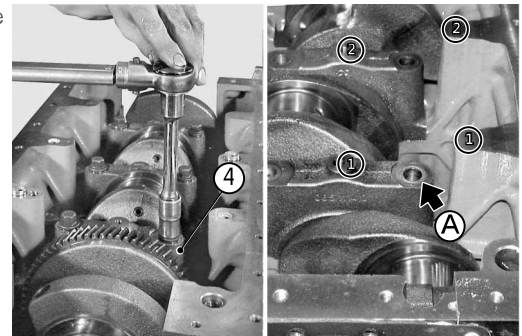

3.

Remove the screws and remove front main bearing (5) complete with main bearing shell (6).



NOTE

Label the main bearing shell and front main bearing for the following dimensional check.



NOTE

When removing the bearing remove also the triangular seals and be sure to renew them at the time of reassembly.

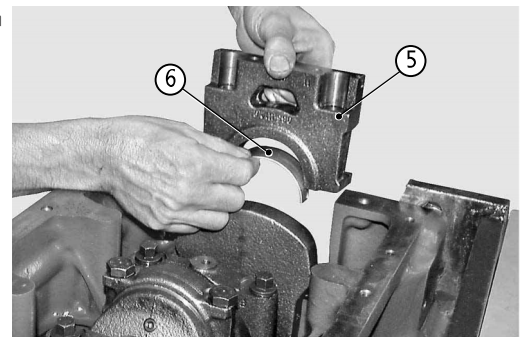

4.

Remove the screws and remove rear main bearing (7) complete with main bearing shell and crankshaft half thrust washers (8).



NOTE

Label the main bearing shell and rear main bearing for the following dimensional check.



NOTE

Note the direction of installation of the half thrust washers, the oil grooves of which must face the crankshaft are installed.



NOTE

When removing the bearing remove also the triangular seals and be sure to renew them at the time of reassembly.

5.

Attach crankshaft (1) to a hoist with soft belt and lift it clear of the engine.

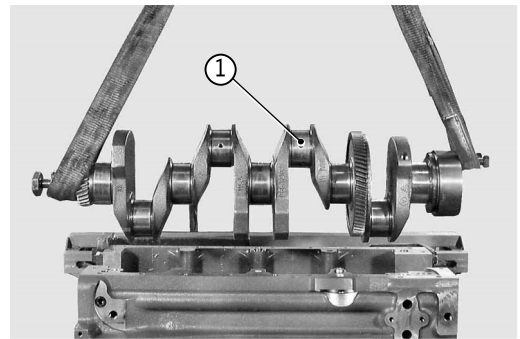
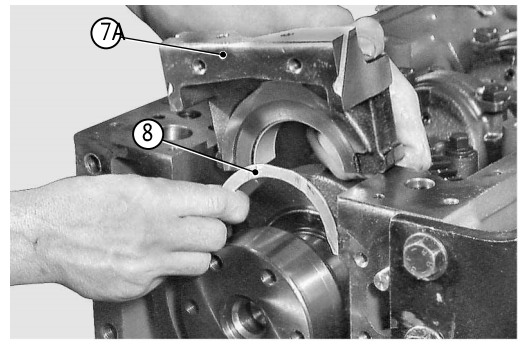

6.

Remove lower half thrust washers (9) and main bearing shells (10).



NOTE

Label the positions of the main bearing shells for the following dimensional check.

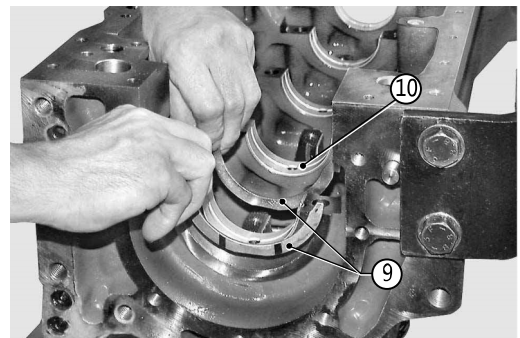

7.

Remove tappets (11) from the block.



NOTES

Carefully check that the contact surface of each tappet with the cam is perfectly smooth. Renew any tappets showing signs of a pitted or rough surface.

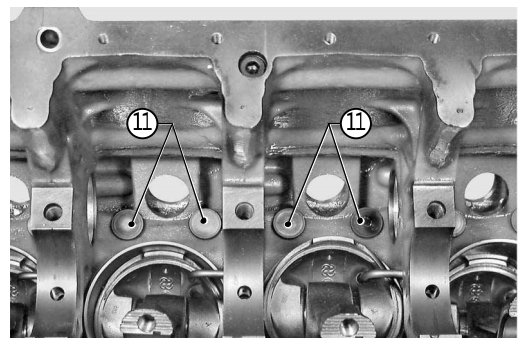

8.

Remove nut (12) and remove washer jets (13) and relative seals.

NOTE

Thank you so much for reading.
Please click the “Buy Now!”
button below to download the
complete manual.



After you pay.

You can download the most
perfect and complete manual in
the world immediately.

Our support email:

ebooklibonline@outlook.com