

# OPERATOR'S MANUAL

# ROTARY RAKE

RR1012E

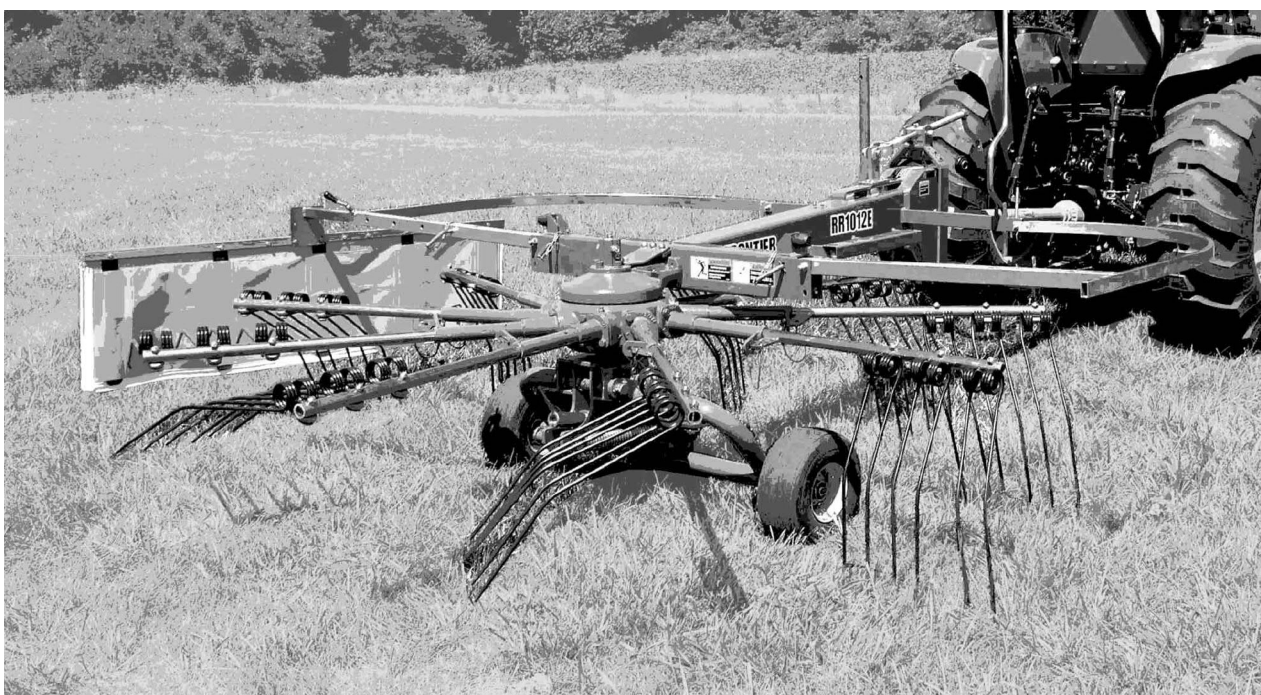

**FRONTIER**  
EQUIPMENT™

OMUS00RRF (10/21/08)

## INTRODUCTION

READ THIS MANUAL carefully to learn how to operate and service your machine correctly. Failure to do so could result in personal injury or equipment damage. This manual and safety signs on your machine may also be available in other languages. (See your Frontier dealer to order.)

THIS MANUAL SHOULD BE CONSIDERED a permanent part of your machine and should remain with the machine when you sell it.

MEASUREMENTS in this manual are given in both metric and customary U.S. unit equivalents. Use only correct replacement parts and fasteners. Metric and inch fasteners may require a specific metric or inch wrench.

RIGHT-HAND AND LEFT-HAND sides are determined by facing in the direction the implement will travel when going forward.

### WRITE PRODUCT IDENTIFICATION NUMBERS

(P.I.N.) in the Specification section. Accurately record all the numbers to help in tracing the machine should it be stolen. Your dealer also needs these numbers when you order parts. File the identification numbers in a secure place off the machine.

WARRANTY is provided as part of Frontier's support program for customers who operate and maintain their equipment as described in this manual.

This warranty provides you the assurance that Frontier will back its products where defects appear within the warranty period. In some circumstances, Frontier also provides field improvements, often without charge to the customer, even if the product is out of warranty. Should the equipment be abused, or modified to change its performance beyond the original factory specifications, the warranty will become void and field improvements may be denied. Setting fuel delivery above specifications or otherwise overpowering machines will result in such action.

THE TIRE MANUFACTURER'S warranty applicable to your machine may not apply outside the U.S.

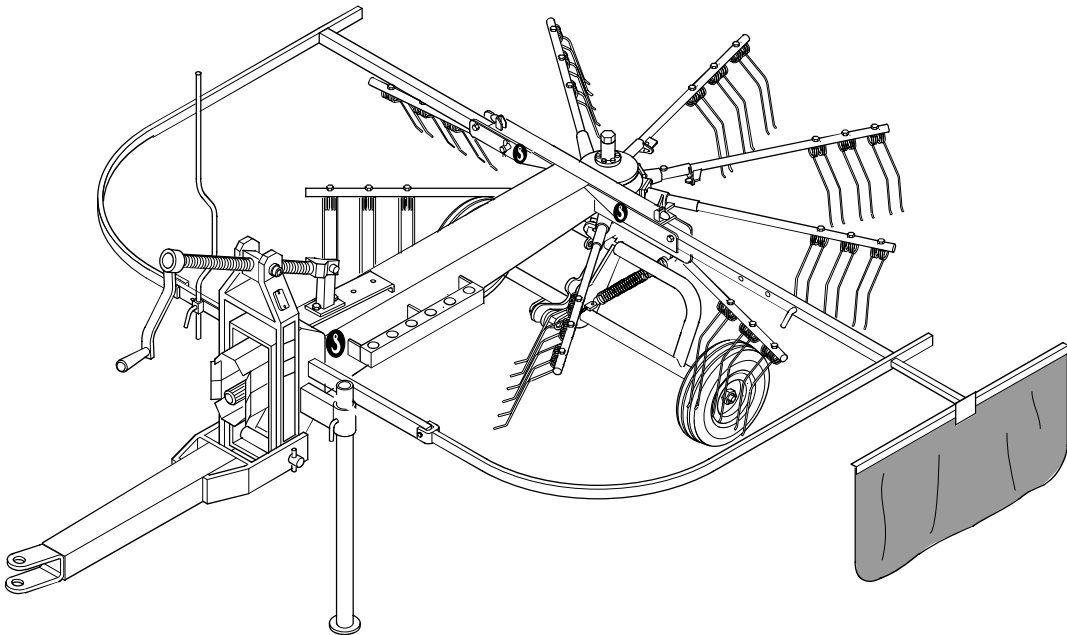

## TABLE OF CONTENTS

	Page
SAFETY .....	4
PREPARING THE TRACTOR	
Positioning Tractor Drawbar .....	16
Adjusting the Drawbar .....	16
Using Drawbar Shield .....	16
Making Drawbar Shield .....	17
Three-Point Hitch Position .....	17
Checking Ballast, Wheel Spacing, and Tire Inflation .....	17
PREPARING THE ROTARY RAKE	
Checking Tire Inflation Pressure .....	18
Checking Wheel Nut Torque .....	18
ATTACHING AND DETACHING	
Attaching Rotary Rake to Tractor Drawbar.....	19
Detaching Rake from Tractor .....	20
TRANSPORTING	
Preparing Rotary Rake for Transport.....	21
Weels.....	21
OPERATING THE ROTARY RAKE	
Spring Link Engagement.....	22
Work Position.....	22
Use of the Rotary Rake .....	23
Adjustments .....	23
Spring height Adjustment .....	24
Rake Deflector Adjustment .....	25
During Work .....	25
Operating the Rotary Rake .....	26
LUBRICATION AND MAINTENANCE	
Perform Lubrication and Maintenance .....	27
Observe Lubrication Symbols .....	27
Alternative and Synthetic Lubricants.....	28
Grease.....	28
Lubricant Storage.....	29
Every 20 Hours .....	29
Every 50 Hours .....	31
Annually .....	31
As Required .....	32
SERVICE	
Servicing Tires Safely.....	33

## TABLE OF CONTENTS

Spring Tine Replacement.....	34
STORAGE	
End of Season .....	35
Beginning of Season .....	35
ROTARY RAKE CHECKLISTS	
Dealers Record .....	36
Predelivery .....	36
Delivery .....	37
ASSEMBLY	
Machine.....	38
Fork Assembly.....	38
Drawbar Assembly.....	46
Assembly Adjustment Mechanism.....	47
Guard Assembly.....	48
Curtain and Arm Assembly .....	49
SPECIFICATIONS	
Rotary Rake .....	50
Record Product Identification Number .....	51
Unified Inch Bolt and Cap Screw Torque Values .....	53
Metric Bolt and Cap Screw Torque Values .....	54
SPARE PARTS.....	55-70
DECALS.....	69
ANTISCREW KIT.....	70
NUMERICAL INDEX.....	72
INDEX.....	73

# SAFETY

## SAFETY ALERT SYMBOL



This safety alert symbol indicates important safety messages in this manual and on safety signs on the machine.

This symbol means:

ATTENTION!  
BECOME ALERT!  
YOUR SAFETY IS INVOLVED!

Carefully read and follow the safety message accompanying this symbol.

Why is SAFETY important to you?

- 3 BIG REASONS
- ACCIDENTS DISABLE AND KILL
  - ACCIDENTS COST
  - ACCIDENTS CAN BE AVOIDED

## SIGNAL WORDS

Note the use of the signal words DANGER, WARNING, and CAUTION with safety messages. The appropriate signal word for each message has been selected using the following guidelines:



**DANGER** – Indicates an imminently hazardous situation that, if not avoided, will result in death or serious injury.



**WARNING** – Indicates a potentially hazardous situation that, if not avoided, could result in death or serious injury. It is also used to alert against unsafe practices.



**CAUTION** – Indicates a potentially hazardous situation that, if not avoided, may result in minor or moderate injury. It is also used as a reminder of good safety practices.

## **SAFETY**

### **FOLLOW SAFETY INSTRUCTIONS**

Carefully read all safety messages in this manual and on your machine safety signs. Keep safety signs in good condition. Replace missing or damaged safety signs. Be sure new equipment components and repair parts include the current safety signs. Replacement safety signs are available from your Frontier dealer.

Learn how to operate the machine and how to use controls properly. Do not let anyone operate without instruction.

Keep your machine in proper working condition. Unauthorized modifications to the machine may impair the function and/or safety and affect machine life.

If you do not understand any part of this manual and need assistance, contact your Frontier dealer.



### **OPERATE ROTARY RAKE SAFELY**

All machinery should be operated by responsible persons who have been properly instructed and delegated to do so.

Before each use, inspect entire machine. Check tightness of all hardware.

Stop the tractor engine and engage parking brake before leaving tractor operator's station to adjust, lubricate, clean or unclog the machine.

Never hand feed material into the machine.

Do not lean against, sit, or stand on rake.

## **SAFETY**

### **KEEP RIDERS OFF MACHINE**

Only allow the operator on the machine. Keep riders off.

Riders on machine are subject to injury such as being struck by foreign objects and being thrown off of the machine. Riders also obstruct the operator's view resulting in the machine being operated in an unsafe manner.

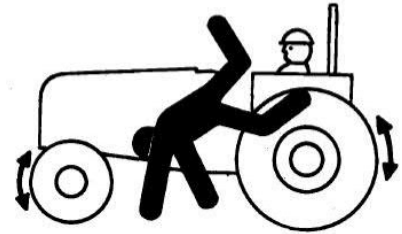

### **PREPARE FOR EMERGENCIES**

Be prepared if a fire starts.

Keep a first aid kit and fire extinguisher handy.

Keep emergency numbers for doctors, ambulance service, hospital, and fire department near your telephone.

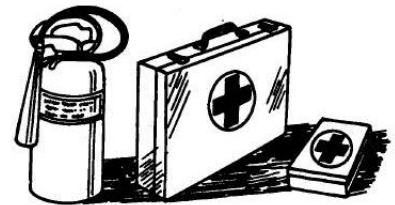

### **WEAR PROTECTIVE CLOTHING**

Wear close fitting clothing and safety equipment appropriate to the job.

Operating equipment safely requires the full attention of the operator. Do not wear radio or music headphones while operating machine.

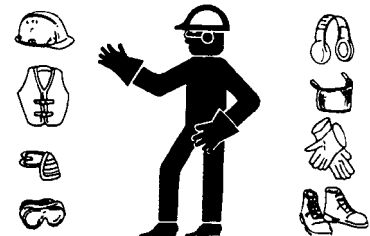

## SAFETY

### HANDLE CHEMICAL PRODUCTS SAFELY

Direct exposure to hazardous chemicals can cause serious injury. Potentially hazardous chemicals used with Frontier equipment include such items as lubricants, coolants, paints, and adhesives.

A Material Safety Data Sheet (MSDS) provides specific details on chemical products: physical and health hazards, safety procedures, and emergency response techniques.

Check the MSDS before you start any job using a hazardous chemical. That way you will know exactly what the risks are and how to do the job safely. Then follow procedures and recommended equipment.

(See your Frontier dealer for MSDS's on chemical products used with Frontier equipment.)



### USE SAFETY LIGHTS AND DEVICES

Prevent collisions between other road users, slow moving tractors with attachments or towed equipment, and self-propelled machines on public roads. Frequently check for traffic from the rear, especially in turns, and use hand signals or turn signal lights.

Use headlights, flashing warning lights, and turn signals day and night. Follow local regulations for equipment lighting and marking. Keep lighting and marking visible and in good working order. Replace or repair lighting and marking that has been damaged or lost.

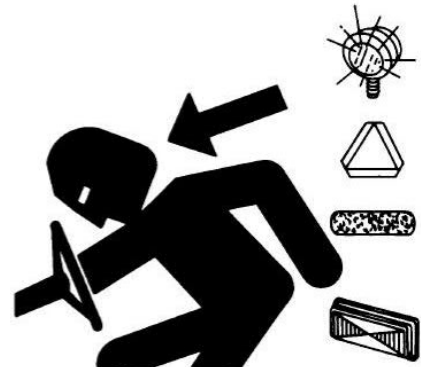



## SAFETY

### USE A SAFETY CHAIN

A safety chain will help control drawn equipment should it accidentally separate from the drawbar.

Using the appropriate adapter parts, attach the chain to the tractor drawbar support or other specified anchor location. Provide only enough slack in the chain to permit turning.

See your Frontier dealer for a chain with a strength rating equal to or greater than the gross weight of the towed machine. Do not use safety chain for towing.

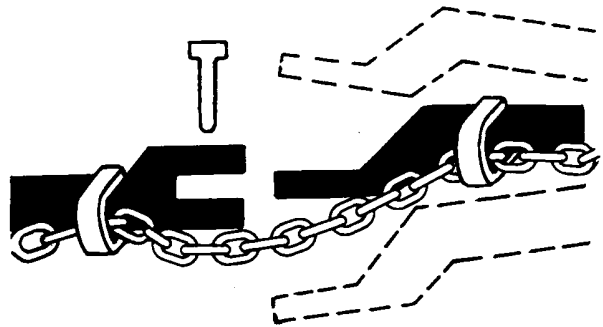

### TOW LOADS SAFELY

Stopping distance increases with speed and weight of towed loads, and on slopes. Towed loads with or without brakes that are too heavy for the tractor or are towed too fast can cause loss of control. Consider the total weight of the equipment and its load.

Observe these recommended maximum road speeds, or local speed limits which may be lower:

- If towed equipment does not have brakes, do not travel more than 32 km/h (20 mph) and do not tow loads more than 1.5 times the tractor weight.
- If towed equipment has brakes, do not travel more than 40 km/h (25 mph) and do not tow loads more than 4.5 times the tractor weight.

Ensure the load does not exceed the recommended weight ratio. Add ballast to recommended maximum for tractor, lighten the load, or get a heavier towing unit. The tractor must be heavy and powerful enough with adequate braking power for the towed load. Use additional caution when towing loads under adverse surface conditions, when turning, and on inclines.

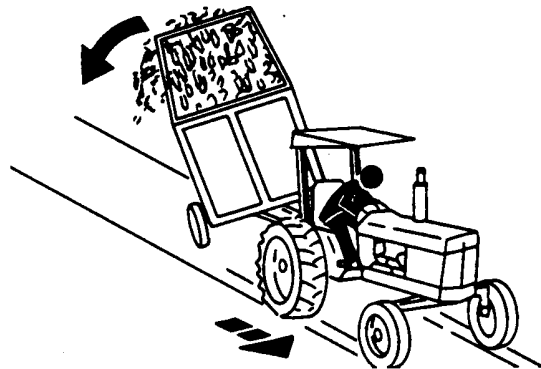

## SAFETY

### SERVICE RAKE SAFELY

To help prevent injury caused by unexpected movement, be sure to service machine on level surface.

Lower rake before servicing or adjusting rake.

If machine is connected to a tractor:

- Engage tractor parking brake and/or place transmission in "Park."
- Shut off engine and remove key.

If machine is detached from tractor, block wheels and use safety stands to prevent movement.

To avoid eye injuries, cuts and bruises, take care when working around raised tines. Do not service or adjust machine with tines raised.

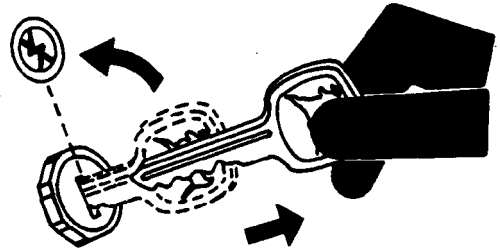

### PRACTICE SAFE MAINTENANCE

Understand service procedure before doing work. Keep area clean and dry.

Never lubricate, service, or adjust machine while it is moving. Keep hands, feet, and clothing from power-driven parts. Disengage all power and operate controls to relieve pressure. Lower equipment to the ground. Stop the engine. Remove the key. Allow machine to cool.

Securely support any machine elements that must be raised for service work.

Keep all parts in good condition and properly installed. Fix damage immediately. Replace worn or broken parts. Remove any buildup of grease, oil, or debris.

Disconnect battery ground cable (-) before making adjustments on electrical systems or welding on machine.



## SAFETY

### REMOVE PAINT BEFORE WELDING OR HEATING

Avoid potentially toxic fumes and dust.

Hazardous fumes can be generated when paint is heated by welding, soldering, or using a torch.

Do all work outside or in a well ventilated area. Dispose of paint and solvent properly.

Remove paint before welding or heating:

- If you sand or grind paint, avoid breathing the dust. Wear an approved respirator.
- If you use solvent or paint stripper, remove stripper with soap and water before welding. Remove solvent or paint stripper containers and other flammable material from area. Allow fumes to disperse at least 15 minutes before welding or heating.



### AVOID HEATING NEAR PRESSURIZED FLUID LINES

Flammable spray can be generated by heating near pressurized fluid lines, resulting in severe burns to yourself and bystanders. Do not heat by welding, soldering, or using a torch near pressurized fluid lines or other flammable materials. Pressurized lines can be accidentally cut when heat goes beyond the immediate flame area.



Thank you so much for reading.  
Please click the “Buy Now!”  
button below to download the  
complete manual.



After you pay.

You can download the most  
perfect and complete manual in  
the world immediately.

Our support email:

[ebooklibonline@outlook.com](mailto:ebooklibonline@outlook.com)