

900 Series Cutting Platforms

**John Deere Harvester Works
OMH168627 Issue I8
(This manual replaces OMH161707 I7)**

LITHO IN U.S.A.
ENGLISH

Introduction

READ THIS MANUAL carefully to learn how to operate and service your machine correctly. Failure to do so could result in personal injury or equipment damage. This manual and safety signs on your machine may also be available in other languages. (See your John Deere dealer to order.)

THIS MANUAL SHOULD BE CONSIDERED a permanent part of your machine and should remain with the machine when you sell it.

MEASUREMENTS in this manual are given in both metric and customary U.S. unit equivalents. Use only correct replacement parts and fasteners. Metric and inch fasteners may require a specific metric or inch wrench.

RIGHT-HAND AND LEFT-HAND sides are determined by facing in the direction the implement will travel when going forward.

WRITE PRODUCT IDENTIFICATION NUMBERS (P.I.N.) in the Specification section. Accurately record

all the numbers to help in tracing the machine should it be stolen. Your dealer also needs these numbers when you order parts. File the identification numbers in a secure place off the machine.

WARRANTY is provided as part of John Deere's support program for customers who operate and maintain their equipment as described in this manual. The warranty is explained on the warranty certificate which you should have received from your dealer.

This warranty provides you the assurance that John Deere will back its products where defects appear within the warranty period. In some circumstances, John Deere also provides field improvements, often without charge to the customer, even if the product is out of warranty. Should the equipment be abused, or modified to change its performance beyond the original factory specifications, the warranty will become void and field improvements may be denied. Setting fuel delivery above specifications or otherwise overpowering machines will result in such action.

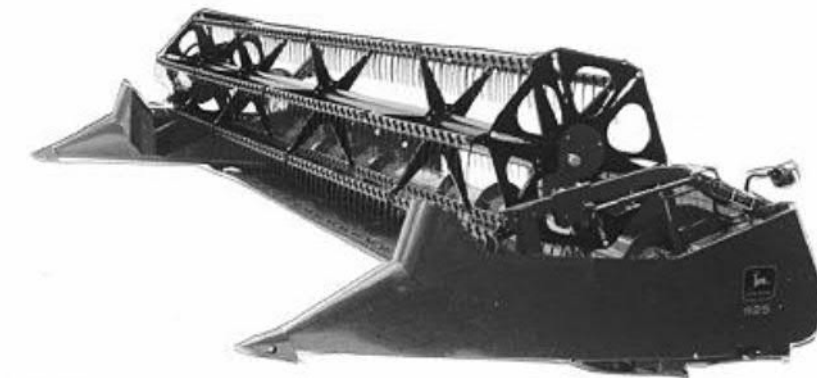

H44949

-JUN-03DEC92

H44949

HX,H161707,IFC -19-18AUG97

Contents

	Page
Platform Safety Features	05-1
Safety	10-1
Safety Decal Location	15-1
Attaching and Detaching	20-1
Transporting	25-1
Operating the Platform	30-1
Flex Platform Adjustments	35-1
Rigid Platform Adjustments	40-1
Auger and Stripper Adjustments	45-1
Reel Adjustments	50-1
Lubricants	55-1
Lubrication and Maintenance	60-1
Trouble Shooting	65-1
Service	70-1
Storage	75-1
Specifications	80-1
Crime Prevention Tips	85-1

John Deere Service Literature Available

Index

All information, illustrations and specifications in this manual are based on the latest information available at the time of publication. The right is reserved to make changes at any time without notice.

OMH168627 18-19-31AUG98

COPYRIGHT© 1998
DEERE & COMPANY
Moline, Illinois
All rights reserved
A John Deere ILLUSTRATION® Manual
Previous Editions
Copyright1997 Deere & Company

Platform Safety Features

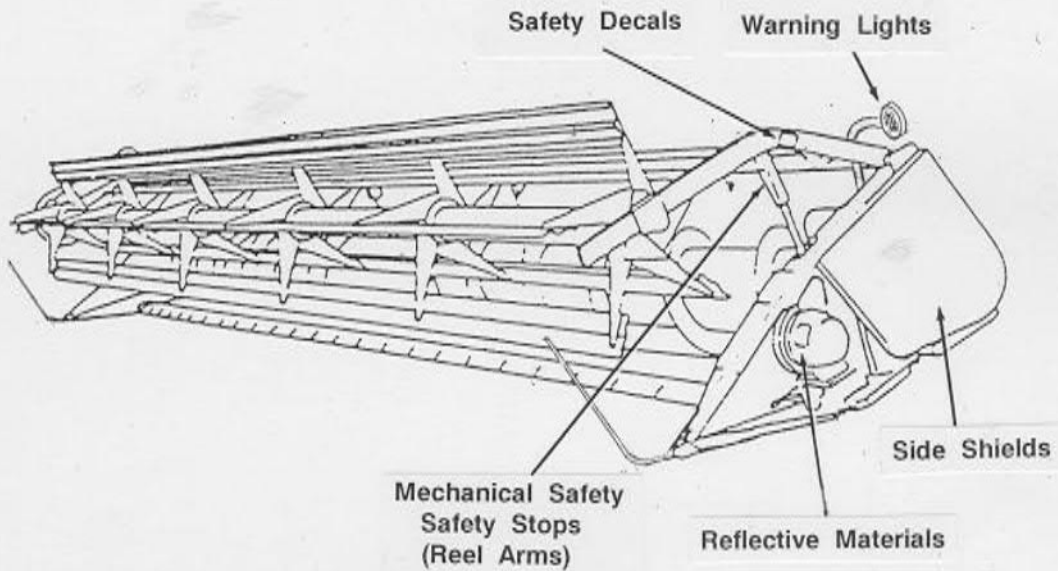

In addition to the safety features shown here, safety signs on the platform, and safety messages and instructions in the operator's manual contribute to the safe operation of this platform when combined with the care and concern of a capable operator.

H48262

H48262
-UN-21MAY97

HX,900PSF,A -19-18AUG97

Safety

RECOGNIZE SAFETY INFORMATION

This is the safety-alert symbol. When you see this symbol on your machine or in this manual, be alert to the potential for personal injury.

Follow recommended precautions and safe operating practices.



DX,ALERT -19-03MAR93

T81389 -UN-07DEC68

UNDERSTAND SIGNAL WORDS

A signal word—DANGER, WARNING, or CAUTION—is used with the safety-alert symbol. DANGER identifies the most serious hazards.

DANGER or WARNING safety signs are located near specific hazards. General precautions are listed on CAUTION safety signs. CAUTION also calls attention to safety messages in this manual.



DX,SIGNAL -19-03MAR93

TS187 -19-30SEP88

FOLLOW SAFETY INSTRUCTIONS

Carefully read all safety messages in this manual and on your machine safety signs. Keep safety signs in good condition. Replace missing or damaged safety signs. Be sure new equipment components and repair parts include the current safety signs. Replacement safety signs are available from your John Deere dealer.

Learn how to operate the machine and how to use controls properly. Do not let anyone operate without instruction.

Keep your machine in proper working condition. Unauthorized modifications to the machine may impair the function and/or safety and affect machine life.

If you do not understand any part of this manual and need assistance, contact your John Deere dealer.

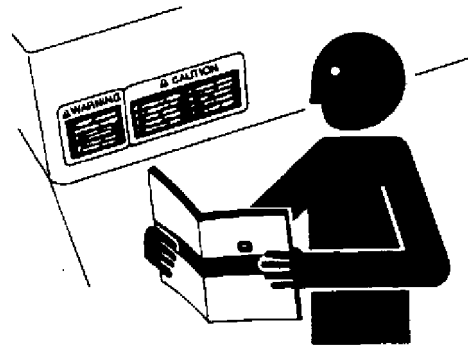

DX,READ -19-03MAR93

TS201 -UN-23AUG88



WEAR PROTECTIVE CLOTHING

Wear close fitting clothing and safety equipment appropriate to the job.

Operating equipment safely requires the full attention of the operator. Do not wear radio or music headphones while operating machine.

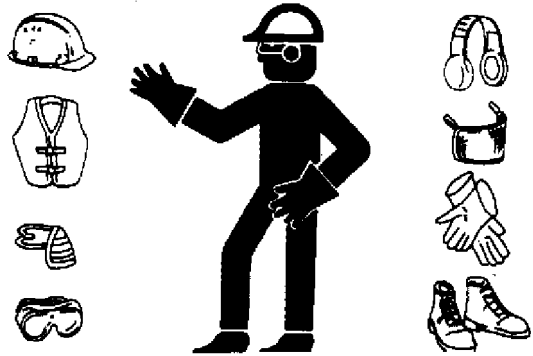

DX,WEAR2 -19-03MAR93

TS206 -UN-23AUG88

PARK MACHINE SAFELY

Before working on the machine:

- Lower all equipment to the ground.
- Stop the engine and remove the key.
- Disconnect the battery ground strap.
- Hang a "DO NOT OPERATE" tag in operator station.

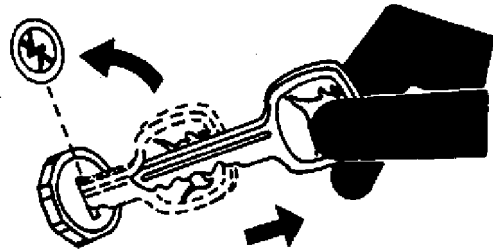

DX,PARK -19-04JUN90

TS230 -UN-24MAY89

AVOID CONTACT WITH MOVING PARTS

Keep hands, feet and clothing away from power driven parts. Never clean, lubricate or adjust machine when it is running.



900CP,SA,E -19-24JAN91

TS256 -UN-23AUG88

AVOID CONTACT WITH CUTTERBAR

Never attempt to clear obstructions off cutting platform unless separator is disengaged and engine is shut off and key removed. Everyone must be clear before starting engine or running combine.



900CP,SA,F -19-24JAN91

TS268 -UN-23AUG88



TRANSPORTING SAFELY

Check local width laws before transporting. It is not recommended to transport on road with 930 Platform attached to combine. It is recommended that you use a Model 25 Transport Frame for the 900 Series Platform.

900CP_SA,G -19-24JAN91

USE SAFETY LIGHTS AND DEVICES

Prevent collisions between other road users, slow moving tractors with attachments or towed equipment, and self-propelled machines on public roads. Frequently check for traffic from the rear, especially in turns, and use hand signals or turn signal lights.

Use headlights, flashing warning lights, and turn signals day and night. Follow local regulations for equipment lighting and marking. Keep lighting and marking visible and in good working order. Replace or repair lighting and marking that has been damaged or lost. An implement safety lighting kit is available from your John Deere dealer.

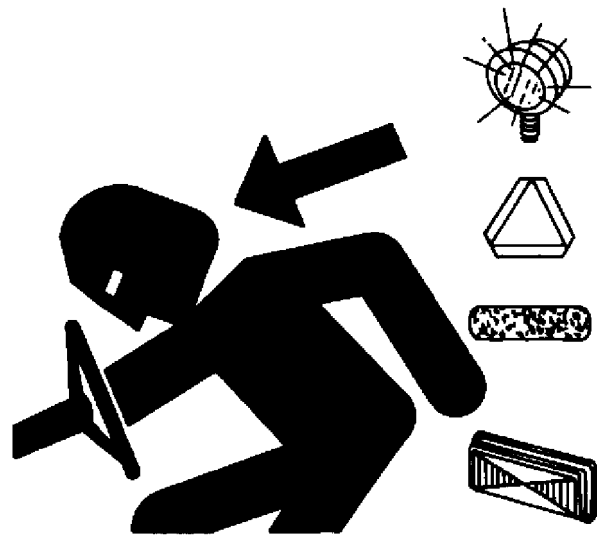

TS951 -UN-12APR90

DX,FLASH -19-12SEP95



REMOVE PAINT BEFORE WELDING OR HEATING

Avoid potentially toxic fumes and dust.

Hazardous fumes can be generated when paint is heated by welding, soldering, or using a torch.

Do all work outside or in a well ventilated area. Dispose of paint and solvent properly.

Remove paint before welding or heating:

- If you sand or grind paint, avoid breathing the dust. Wear an approved respirator.
- If you use solvent or paint stripper, remove stripper with soap and water before welding. Remove solvent or paint stripper containers and other flammable material from area. Allow fumes to disperse at least 15 minutes before welding or heating.

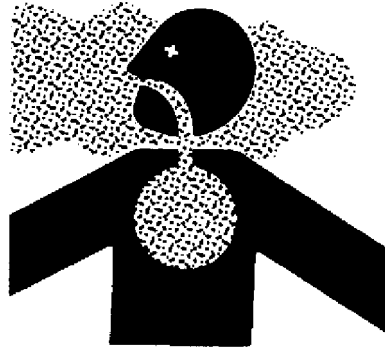

DX,PAINT -19-03MAR93

TS220 -UN-23AUG68

AVOID HEATING NEAR PRESSURIZED FLUID LINES

Flammable spray can be generated by heating near pressurized fluid lines, resulting in severe burns to yourself and bystanders. Do not heat by welding, soldering, or using a torch near pressurized fluid lines or other flammable materials. Pressurized lines can be accidentally cut when heat goes beyond the immediate flame area.



DX,TORCH -19-03MAR93

TS953 -UN-15MAY90

Safety Decal Location



⚠ DANGER

Entanglement in rotating driveline can cause serious injury or death.

Keep all shields in place.

Avoid contact with rotating parts.

SideHill 6620, SideHill 9500,
SideHill 9510 and Combines with
Contour Master Only



CAUTION

1. Keep all shields in place.
2. Disengage and shut off all engine and/or motor power before servicing or unclogging machine.
3. Keep hands, feet, and clothing away from power-driven parts.



RED

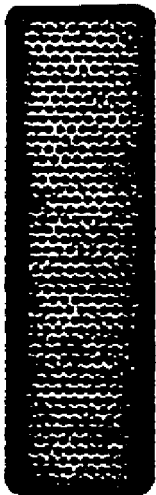
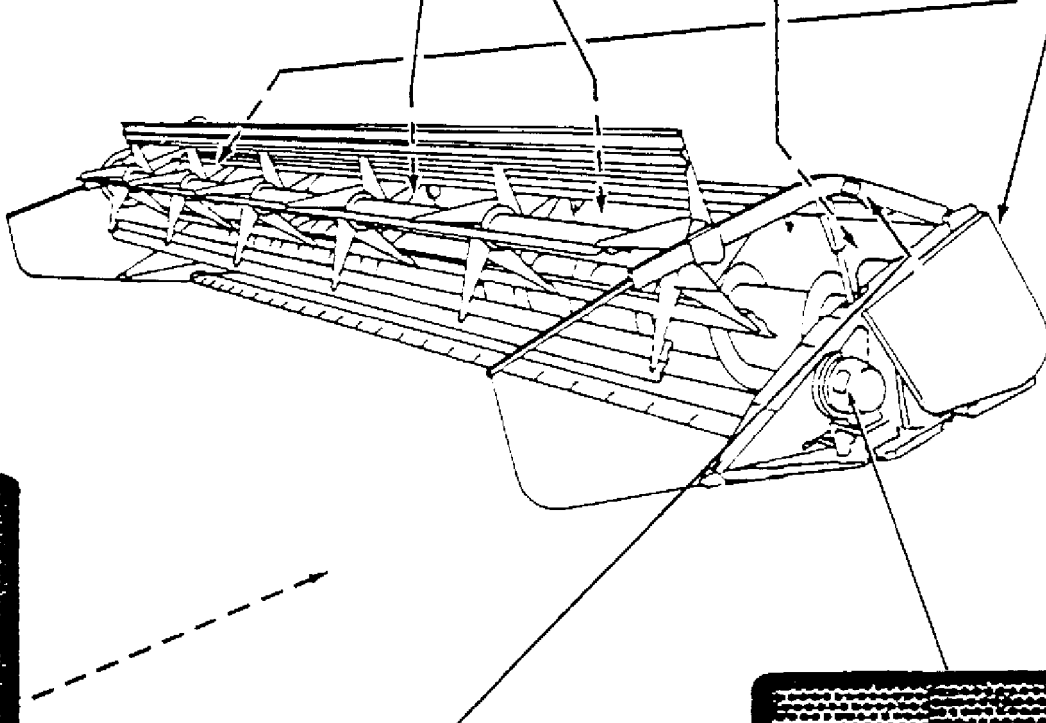

AMBER
(ON FLEX
PLATFORM
FLOATING POINT)

H49852



WARNING

To avoid bodily injury from fall of raised reel, completely raise reel, stop engine, remove start key, and set safety stop on each lift cylinder rod before working on or under reel. Safety stop is located on each reel arm above cylinder rod.

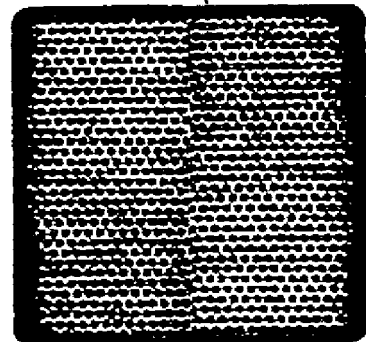

AMBER

-UN-14NOV97

H49852

900CP,SS,A -19-17NOV97

Attaching and Detaching

CHECK AUGER STRIPPER LOCATION

The auger strippers (A) are positioned in three different locations (B), (C) and (D) depending on the size of combine the platform will be used on.

The strippers are shipped from the factory with the auger strippers in position (C).

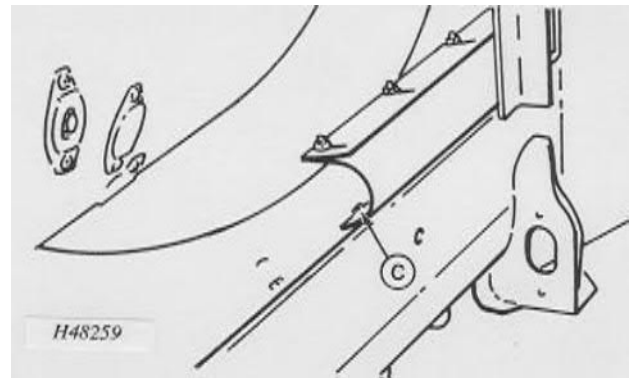
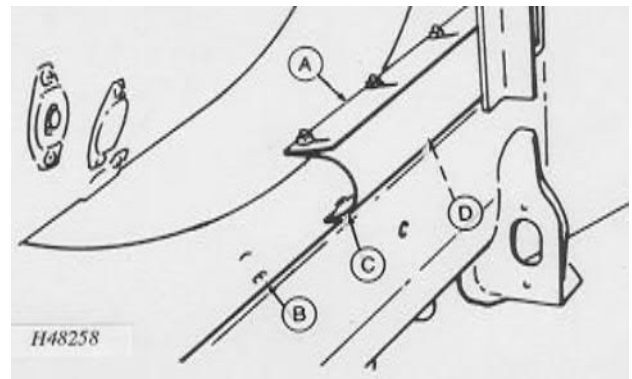

900CP,AD,AQ -19-09JAN98

For platforms 25-ft or larger, the strippers are shipped from the factory with the auger strippers in position (D).

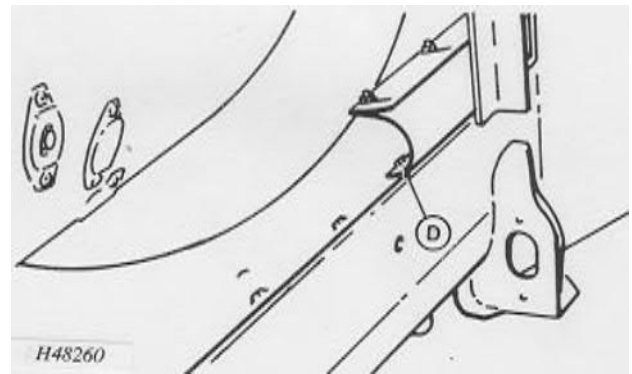

900CP,AD,BF -19-09JAN98

(4425, 4435 and 6620 Combines) Remove cap screws securing auger stripper. Install stripper with inner hole of stripper support over hole (B) (hole closest to the center of platform floor).

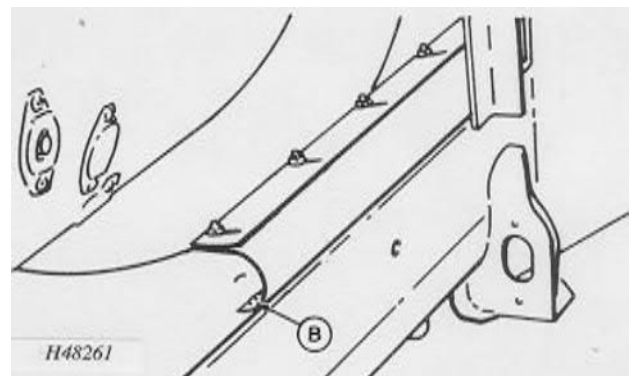

900CP,AD,BG -19-18AUG97

ATTACHING PLATFORM TO MAXIMIZER COMBINES

IMPORTANT: If attaching a 1991 model header to a 1990 or older model John Deere combine, you must remove the feeder house strippers (A) from the feeder house.

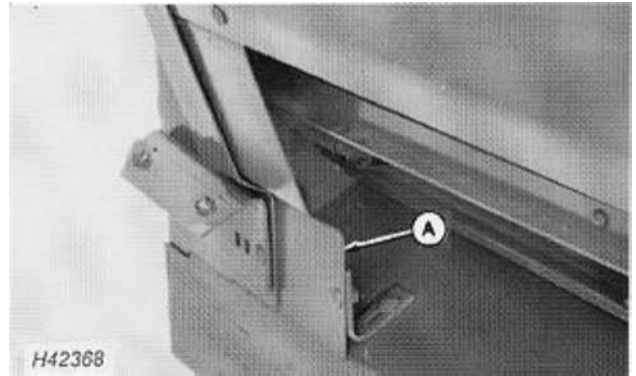

900CP,AD,AR -19-17NOV97

ATTACHING PLATFORM TO COMBINE

IMPORTANT: Lock pin (A) (both sides) must be positioned in before attaching header. Position pin by sliding stop bolt (B) in and then pivoting it up. If pins are left in the out position, feeder house will be damaged when header is attached.

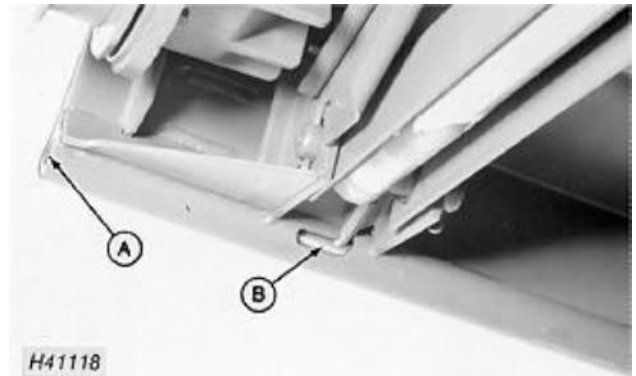

900CP,AD,AD -19-09JAN98

(9400, 9410, 9500 and 9510 Combines) A coupler sprocket must be installed on left-hand platform drive shaft (if attaching combine to 30 ft. platform). See your John Deere dealer.

900CP,AD,AE -19-09JAN98

Start engine, lower feeder house and push and hold minus (-) symbol of variable speed feederhouse switch and reduce speed of the feederhouse to its slowest speed.

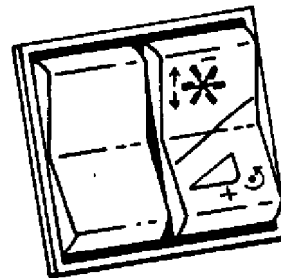

H43707

H43707

900CP,AD,AF -19-18AUG97

Attaching and Detaching

Drive combine slowly forward until feeder house is centered in platform opening.

Raise platform, pivot blocks on feeder house must be seated in pocket (A) under top beam of platform.

Shut off engine and remove key.

Pivot stop handle down to let lock pin (B) lock into header. The lock pin must extend thru latch plate (C). If not, turn plate over. The latch plate must contact surface (D). Tolerances may require that latch plates be installed differently on left-and right-hand sides.

IMPORTANT: Header may detach from combine if latch plate is not in place.

Loosen bolts (E) in bearing brackets and backshaft support. Center opening in support with backshaft. Retighten bolts.

Place chain around sprocket and slide coupler (F) over sprockets and chain.

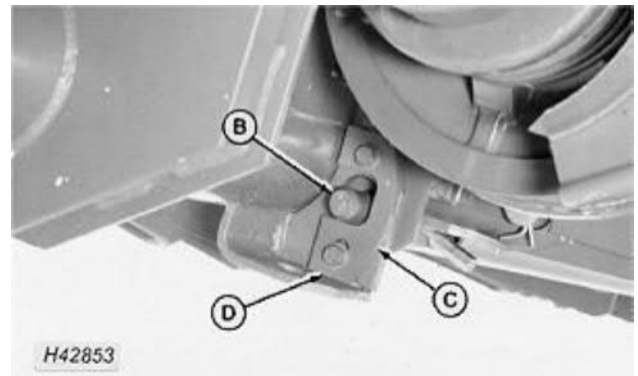
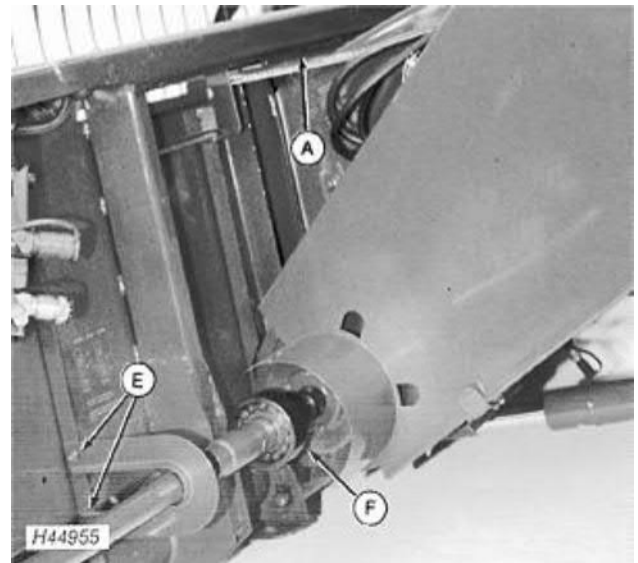

900CP,AD,AG -19-18AUG97

Remove wiring harness (A) from storage position.

Disconnect reel fore/aft hydraulic hose (B) (optional) from quick coupler and install dust cap (C) on coupler.

Unfold reel lift hydraulic hose (D) from storage position.

Left-Hand Side of Feeder House

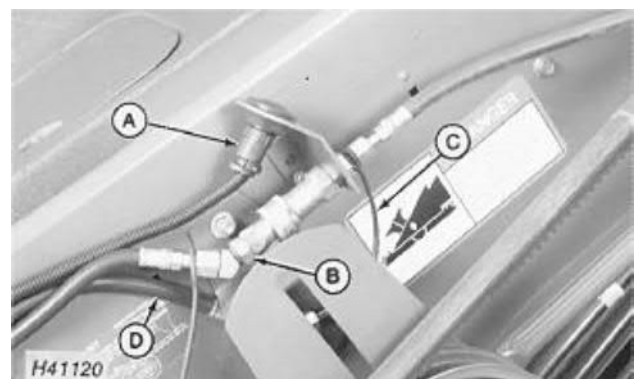

900CP97,AD,AH1 -19-18AUG97

Attaching and Detaching

Remove reel fore/aft hydraulic hose (B) (optional) and reel drive hydraulic hoses (A) from storage position.

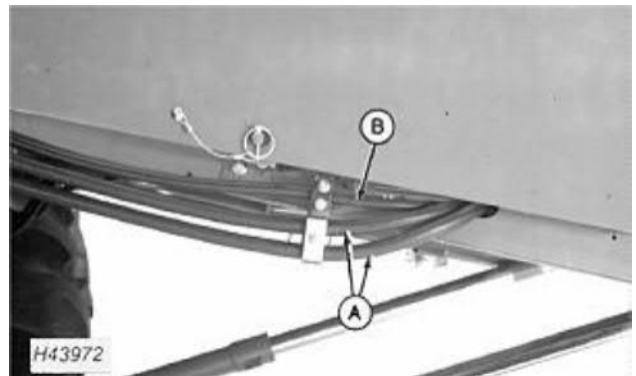

900CP,AD,AI -19-18AUG97

Connect wiring harness (A) to harness on left-hand side of platform.

NOTE: Wiring harness includes warning light circuit and circuitry for optional devices such as DIAL-A-MATIC.

Remove dust cap and connect reel lift hydraulic hose (B) to coupler.

Remove dust cap and connect reel fore/aft hose (C) (optional) to coupler.

Connect dust caps (D) and (E) together.

Open coupling valves.

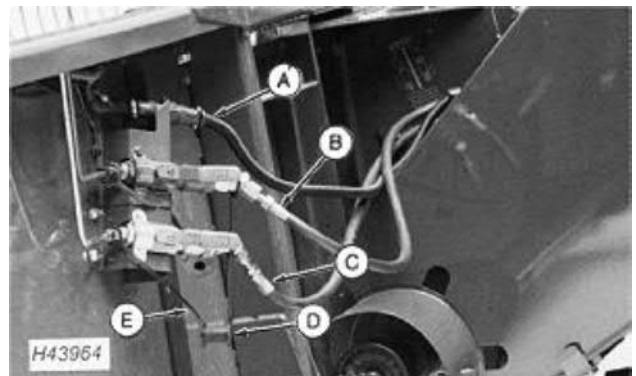

900CP97,AD,AJ1 -19-18AUG97

Remove dust caps and connect reel drive hydraulic hoses (A) to couplers on right-hand side of platform.

Remove dust cap and connect reel fore/aft hydraulic hose (B) (optional) to coupler.

Connect dust caps (C) and (D) together.

Open coupling valves.

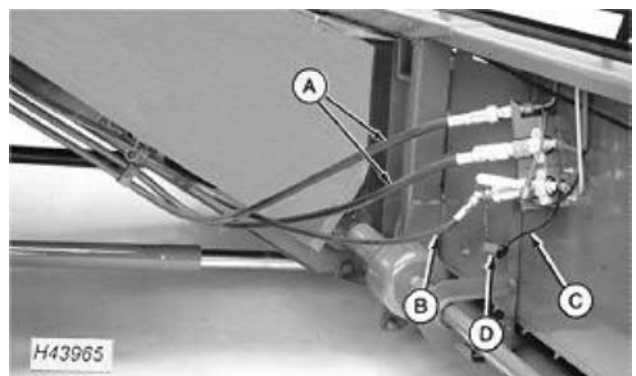

900CP,AD,AK -19-18AUG97

DETACHING PLATFORM FROM COMBINE

Disconnect wiring harness (A) and install cap.

Close coupling valve and disconnect reel lift hose (B) from coupler and install dust cap (F).

Close coupling valve and disconnect reel fore/aft hydraulic hose (C) (optional) from coupler.

Disconnect dust caps (D) and (E) and install on couplers.

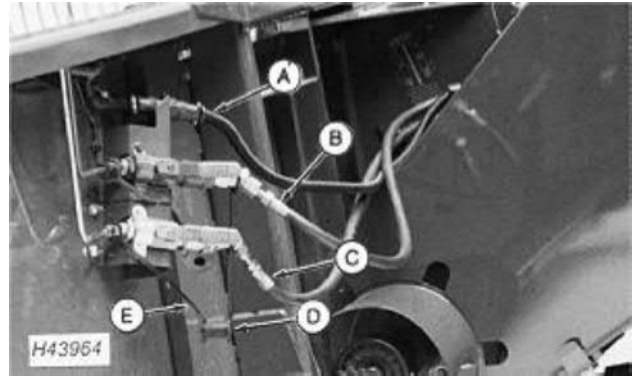

H43964
-UN-24OCT91

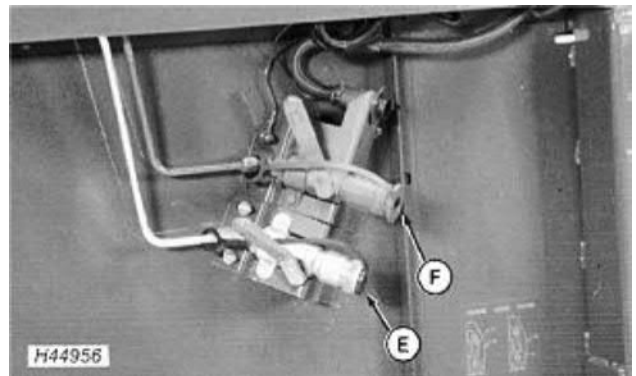

H44956
-UN-25NOV92

900CP97_AD,AL1 -19-09JAN98

Place wiring harness (A) in storage position.

Remove dust cap (C) and connect reel fore/aft hydraulic hose (B) (optional) to quick coupler.

Place reel lift hydraulic hose (D) in storage position.

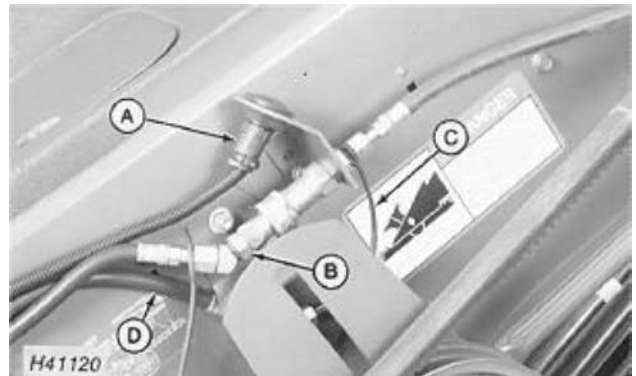

H41120
-UN-25OCT89

900CP97_AD,AM1 -19-18AUG97

Thank you so much for reading.
Please click the “Buy Now!”
button below to download the
complete manual.



After you pay.

You can download the most
perfect and complete manual in
the world immediately.

Our support email:

ebooklibonline@outlook.com