

400 Series Folding Universal Rotary Hoes



JOHN DEERE

OPERATORS MANUAL 400 Series Folding Universal Rotary Hoes

OMN159547 G0 English

Des Moines Works
OMN159547 G0

LITHO IN U.S.A.
ENGLISH



INTRODUCTION



This safety alert symbol identifies important safety messages in this manual. When you see this symbol, be alert to the possibility of bodily injury and carefully read the message that follows.

“Right-hand” and “left-hand” sides are determined by facing in the direction the hoe will travel when in use.

Record your model and serial number on page 34.

Your warranty appears on your copy of the purchase order which you should have received from your dealer.

Measurements are shown with their respective Metric equivalents in parenthesis throughout this operator's manual. These equivalents are the SI (International System) Units of Measure.

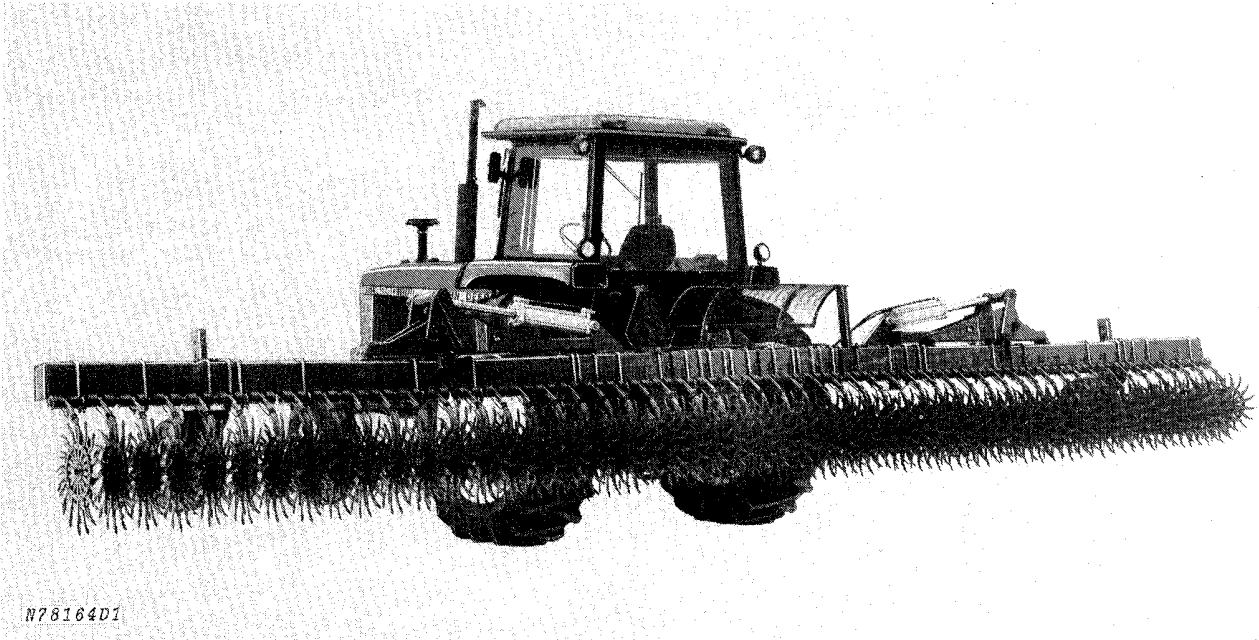

N78164D1

John Deere Model 430 Folding Universal Rotary Hoe



Contents

	Page
SAFETY	2-3
PREPARING TRACTOR	4-6
PREPARING ROTARY HOE	7-8
ATTACHING AND DETACHING.....	9-11
Attaching	9
Leveling.....	10
Detaching	11
TRANSPORTING.....	12
OPERATING THE ROTARY HOE	13-16
Soil Penetration.....	13
Hoe Wheels and Shield	14
Primary Arms and J-Bolts.....	14
Secondary Arms	14
Frame Gauge Wheels	15
Mounting Tires.....	15
Tightening Hardware	15
Lift-Assist Wheel Attachment	16
LUBRICATION.....	17
STORAGE.....	18
ASSEMBLY.....	19-28
Lift-Assist Wheel Attachment	22
Hydraulic Hose Diagrams.....	27-30
SPECIFICATIONS	31-34
Serial Number	34
Torque Value Chart	34



Safety

Operate Safely

DO NOT operate hoe without reading this operator's manual.

DO NOT allow anyone to ride on, walk behind, or near the hoe when it is in motion. Observe operation only from the tractor platform.

Have the rotary hoe stationary and on level ground when raising or lowering outriggers.

Keep safety shield in place when operating.

DO NOT raise or lower the outriggers when moving.

Always shut off tractor engine, shift to "Park", and disengage the PTO when leaving tractor. Remove ignition key when leaving tractor unattended.

Lower the hoe when not in use.

DO NOT operate close to a ditch or creek.

Slow down when turning.

Drive slowly over rough ground.

Prolonged exposure to loud noise can cause impairment or loss of hearing.

Hearing protective devices (such as ear muffs or plugs) can effectively protect against loud noises.

When you are exposed to noise which is objectionable or uncomfortable, it is recommended that you wear a suitable hearing protective device.

Apply both tractor brakes evenly when making emergency stops. Plan ahead.

Wear relatively tight and belted clothing.

DO NOT remove the rotary hoe from the tractor when the hoe is folded or store the hoe in the folded position unless front and rear parking stands are used.

Transport Safely

DO NOT fail to latch the tractor brakes together.

Shift the tractor into a lower gear when transporting down steep slopes or hills.

Keep the SMV emblem and reflectors clean and visible from the rear.

Stop slowly.



N32922

Be aware of overhead wires and know the transport width of the rotary hoe.

When transporting the hoe on a road or highway at night or during the day, use accessory lights and devices for adequate warning to operators of other vehicles. In this regard, check local governmental regulations. Various safety lights and devices are available from your John Deere dealer.

Practice Safe Maintenance

DO NOT lubricate, adjust, or clean the hoe while it is in motion.

Shut off engine and remove key when working on hoe.

Replace any guards and shields removed for servicing.

When mounting a tire on a wheel or rim, failure to follow proper procedure can produce an explosion which can result in serious injury or death. Do not attempt to mount a tire unless you have the proper equipment and experience to perform the job. Have it done by your John Deere dealer or a qualified tire repair service.

Escaping fluid under pressure can have sufficient force to penetrate the skin, causing serious personal injury. Before disconnecting lines, be sure to relieve all pressure. Before applying pressure to the system, be sure all connections are tight and that lines, pipes and hoses are not damaged.

Fluid escaping from a very small hole can be almost invisible. Use a piece of cardboard or wood, rather than hands, to search for suspected leaks.

If injured by escaping fluid, see a doctor at once. Serious infection or reaction can develop if proper medical treatment is not administered immediately.

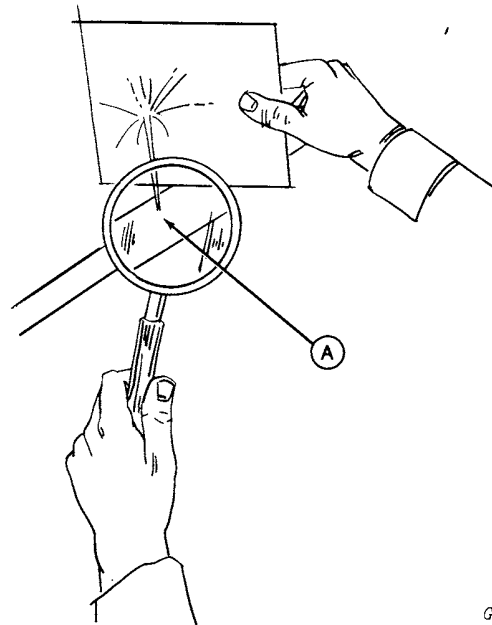

A—Pin Hole Leak

G10317

Avoid Fires

DO NOT refuel with the engine running.

DO NOT smoke or use a lantern when refueling.

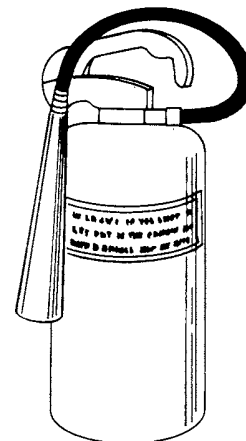

N32054



Preparing Tractor

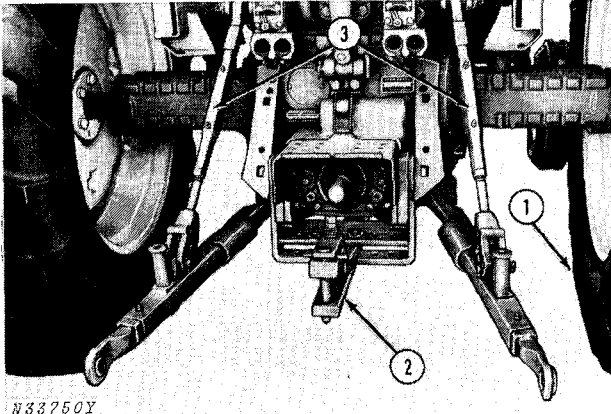

1. Set tractor wheels for desired row spacing. See tractor operator's manual.

CAUTION: Make sure PTO guard and master shield are both installed on tractor.

2. Place drawbar in short, centered position, or remove it.

3. Adjust lift links to minimum length.

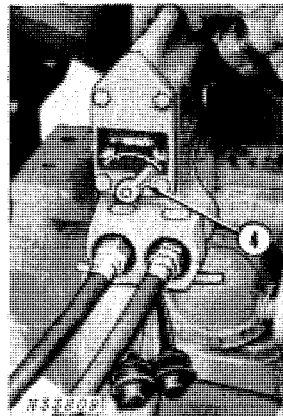

4. Turn metering valves to fast or "Rabbit" position.

5. Check tractor hydraulic oil reservoir and add oil if needed.

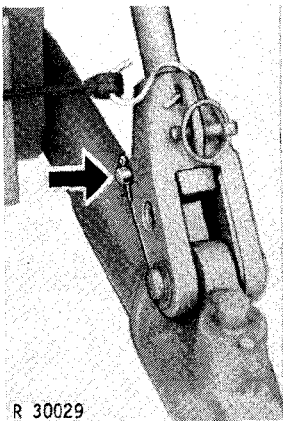

With Gauge Wheels

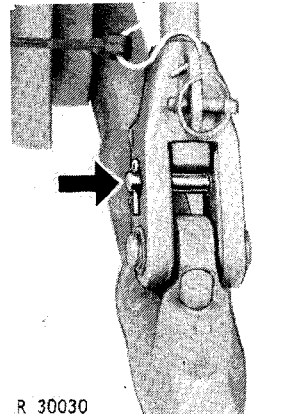

Without Gauge Wheels

6. Set the lift link pins to lock out lateral float unless frame gauge wheels are used.

Thank you so much for reading.
Please click the “Buy Now!”
button below to download the
complete manual.



After you pay.

You can download the most
perfect and complete manual in
the world immediately.

Our support email:

ebooklibonline@outlook.com