

724 Mulch Finisher

John Deere Des Moines Works
OMN200133 Issue K3
(This manual replaces OMN200133 K2)

LITHO IN U.S.A.
ENGLISH

Introduction

READ THIS MANUAL carefully to learn how to operate and service your machine correctly. Failure to do so could result in personal injury or equipment damage. This manual and safety signs on your machine may also be available in other languages. (See your John Deere dealer to order.)

THIS MANUAL SHOULD BE CONSIDERED a permanent part of your machine and should remain with the machine when you sell it.

MEASUREMENTS in this manual are given in both metric and customary U.S. unit equivalents. Use only correct replacement parts and fasteners. Metric and inch fasteners may require a specific metric or inch wrench.

RIGHT-HAND AND LEFT-HAND sides are determined by facing in the direction the implement will travel when going forward.

WRITE PRODUCT IDENTIFICATION NUMBERS (P.I.N.) in the Specification section. Accurately record all the numbers to help in tracing the machine should

it be stolen. Your dealer also needs these numbers when you order parts. File the identification numbers in a secure place off the machine.

WARRANTY is provided as part of John Deere's support program for customers who operate and maintain their equipment as described in this manual. The warranty is explained on the warranty certificate which you should have received from your dealer.

This warranty provides you the assurance that John Deere will back its products where defects appear within the warranty period. In some circumstances, John Deere also provides field improvements, often without charge to the customer, even if the product is out of warranty. Should the equipment be abused, or modified to change its performance beyond the original factory specifications, the warranty will become void and field improvements may be denied. Setting fuel delivery above specifications or otherwise overpowering machines will result in such action.

THE TIRE MANUFACTURER'S warranty applicable to your machine may not apply outside the U.S.

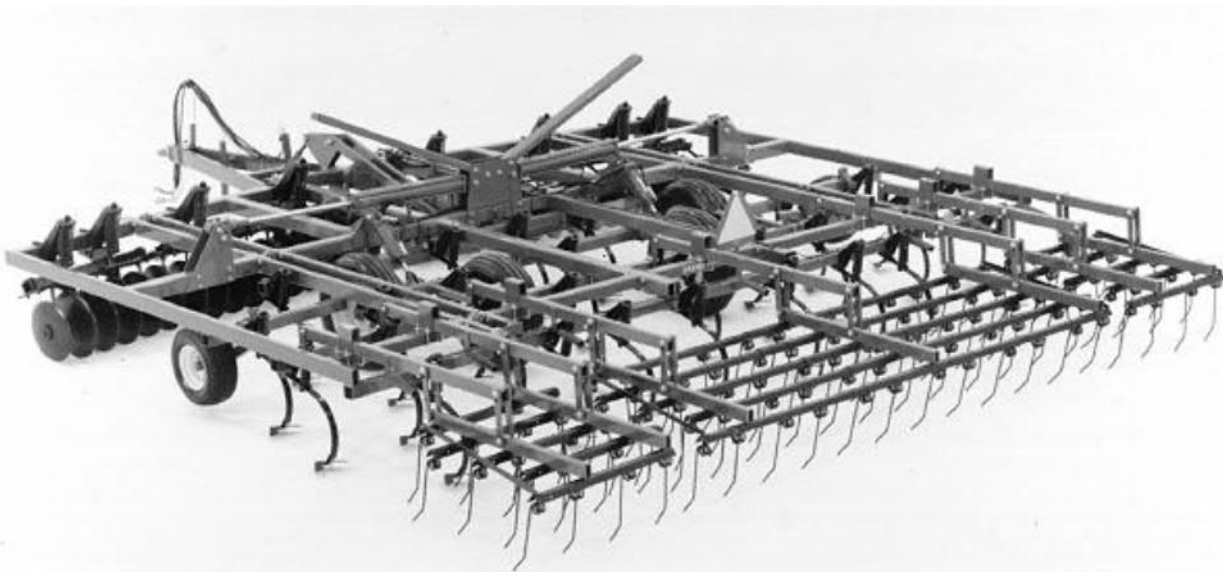

N39488 -UN-04OCT88

N03N,722A,IFC -19-05OCT93

280101
PN=2

Contents

	Page		Page
Safety	05-1	Adjusting Spike Tooth Drag Harrow Angle	30-8
Preparing the Tractor	10-1	Adjusting Spike Tooth Drag Harrow Height	30-9
Preparing the Machine		Adjusting Nozzle Height & Spacing For Spray Attachment	30-9
Check Tire Pressure	15-1	Lubrication and Maintenance	
Leveling the Mulch Finisher	15-1	Lubrication Symbols	35-1
Lubricate Mulch Finisher	15-1	Extreme Pressure Grease	35-1
Attaching and Detaching		Alternative Lubricants	35-2
Attaching to Tractor	20-1	Lubricate Stabilizer Wheel	35-2
Attaching Safety Chain	20-1	Waste Oil	35-2
Hydraulics and Warning Light Attachment	20-2	Discarded Tires	35-3
Checking Depth Control Operation	20-3	Lubricate Every 50 Hours	35-5
Checking Wing Fold Operation	20-3	Troubleshooting	40-1
Detaching Machine From Tractor	20-6	Service	
Transporting	25-1	Safe Service Procedures	45-1
Operating the Machine		Replacing Ground Engaging Tools	45-1
Operating Guidelines	30-1	Repairing Shovels and Sweeps	45-1
Leveling Mulch Finisher	30-1	Service Tires Safely	45-2
Adjusting Single Point Depth Stop Control	30-2	Metric Series Torque Chart	45-3
Adjusting Depth Control	30-3	Inch Series Torque Chart	45-4
Hydraulic Depth Control System	30-3	Checking Wheel Bolts and Bearings	45-5
Positioning Disk Scrapers	30-4	Disk Gang Hardware	45-6
Adjusting Spring Pressure of Disk Gangs	30-4	Gang Bolt Wrenches	45-6
Adjusting Disk Gang Height	30-5	Checking Gang Bolts	45-7
Adjusting Stabilizer Wheel Down Pressure 5.9 m (19 ft 4 in.) Only	30-5	Preventing Contamination	45-8
Leveling Wings		Removing Hydraulic Cylinders	45-9
5.9 m (19 ft 4 in.) Model	30-6	Installing Depth Control Cylinders	45-10
7.5 & 9.2 m (24 ft 8 in. & 30 ft) Models Only	30-6	Installing and Bleeding Wing Fold Cylinders	45-11
Adjusting Wing Stops		Bleeding Depth Control Cylinders	45-12
5.9 m (19 ft 4 in.)	30-7	Single Point Valve-Leakage Check	45-13
7.5 & 9.2 m (24 ft 8 in. & 30 ft)	30-7	Cylinder Leakage Test-Parallel/Series System	45-14
Adjusting Coil Tine Tooth Harrow Height	30-8	Checking Standard Bushings	45-16
		Replacing Split-Tension Bushings	45-17

Continued on next page

All information, illustrations and specifications in this manual are based on the latest information available at the time of publication. The right is reserved to make changes at any time without notice.

OMN200133 K3-19-08SEP93

COPYRIGHT© 1993
DEERE & COMPANY
Moline, Illinois
All rights reserved
A John Deere ILLUSTRATION® Manual
Previous Editions
Copyright 1992, 1991, 1990, 1989, 1988 Deere & Company

Contents

	Page
Identifying Disk Blades	
Eligible For Warranty	45-18
Not Eligible For Warranty	45-19
Storage	50-1
Specifications	
Tractor Recommendations	55-1
Machine Dimensions	55-1
Tire Size and Inflation	55-2
Standards	55-2
Disk Gangs	55-2
Frame Construction	55-3
Standard or Optional Harrows	55-3
Hydraulic Cylinders	55-3
Serial Number	55-4
Crime Prevention Tips	60-1
Index	

Safety

RECOGNIZE SAFETY INFORMATION

This is the safety-alert symbol. When you see this symbol on your machine or in this manual, be alert to the potential for personal injury.

Follow recommended precautions and safe operating practices.

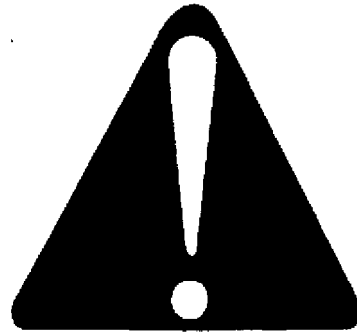

DX,ALERT -19-03MAR93

T81389 -UN-07DEC68

UNDERSTAND SIGNAL WORDS

A signal word—DANGER, WARNING, or CAUTION—is used with the safety-alert symbol. DANGER identifies the most serious hazards.

DANGER or WARNING safety signs are located near specific hazards. General precautions are listed on CAUTION safety signs. CAUTION also calls attention to safety messages in this manual.



DX,SIGNAL -19-03MAR93

TS187 -19-30SEP88

FOLLOW SAFETY INSTRUCTIONS

Carefully read all safety messages in this manual and on your machine safety signs. Keep safety signs in good condition. Replace missing or damaged safety signs. Be sure new equipment components and repair parts include the current safety signs. Replacement safety signs are available from your John Deere dealer.

Learn how to operate the machine and how to use controls properly. Do not let anyone operate without instruction.

Keep your machine in proper working condition. Unauthorized modifications to the machine may impair the function and/or safety and affect machine life.

If you do not understand any part of this manual and need assistance, contact your John Deere dealer.

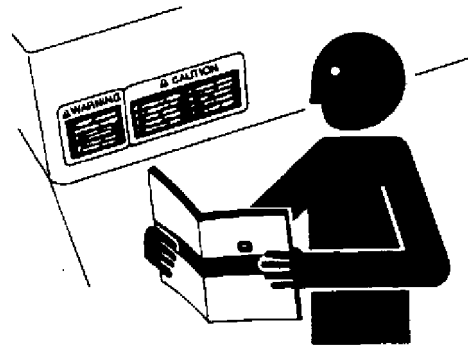

DX,READ -19-03MAR93

TS201 -UN-23AUG88



OPERATE SAFELY

DO NOT allow others to ride on the machine or tractor.

DO NOT operate close to a ditch or creek.

SLOW DOWN when turning and traveling over rough ground OR the machine may tip over.

ALWAYS shut off tractor and shift to "Park" or set brakes when leaving tractor. Remove key when leaving tractor unattended.

BE SURE area around machine is clear before raising or lowering machine.

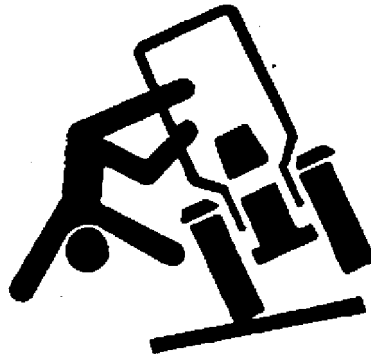

N03,610C,A -19-21DEC87

N39084 -UN-30MAR89

KEEP RIDERS OFF MACHINE

Only allow the operator on the machine. Keep riders off.

Riders on machine are subject to injury such as being struck by foreign objects and being thrown off of the machine. Riders also obstruct the operator's view resulting in the machine being operated in an unsafe manner.

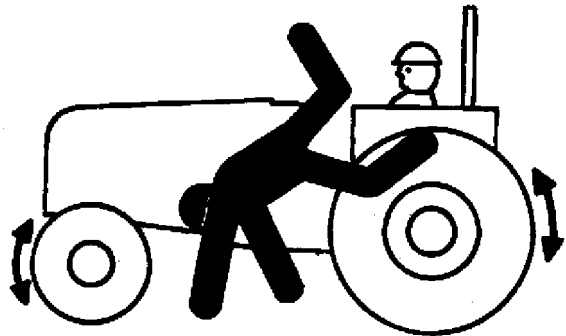

DX,RIDER -19-03MAR93

TS290 -UN-23AUG88

PREPARE FOR EMERGENCIES

Be prepared if a fire starts.

Keep a first aid kit and fire extinguisher handy.

Keep emergency numbers for doctors, ambulance service, hospital, and fire department near your telephone.

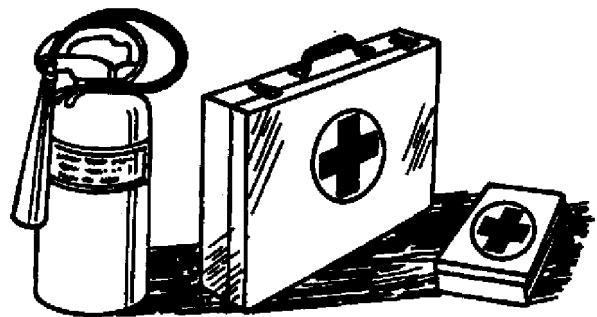

DX,FIRE2 -19-03MAR93

TS291 -UN-23AUG88



WEAR PROTECTIVE CLOTHING

Wear close fitting clothing and safety equipment appropriate to the job.

Operating equipment safely requires the full attention of the operator. Do not wear radio or music headphones while operating machine.

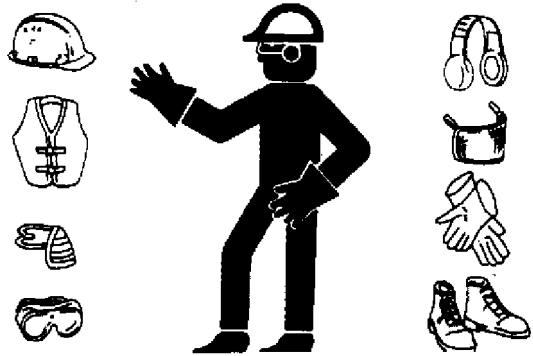

DX,WEAR2 -19-03MAR93

TS206
-UN-23AUG88

PROTECT AGAINST NOISE

Prolonged exposure to loud noise can cause impairment or loss of hearing.

Wear a suitable hearing protective device such as earmuffs or earplugs to protect against objectionable or uncomfortable loud noises.



DX,NOISE -19-03MAR93

TS207
-UN-23AUG88

HANDLE CHEMICAL PRODUCTS SAFELY

Direct exposure to hazardous chemicals can cause serious injury. Potentially hazardous chemicals used with John Deere equipment include such items as lubricants, coolants, paints, and adhesives.

A Material Safety Data Sheet (MSDS) provides specific details on chemical products: physical and health hazards, safety procedures, and emergency response techniques.

Check the MSDS before you start any job using a hazardous chemical. That way you will know exactly what the risks are and how to do the job safely. Then follow procedures and recommended equipment.

(See your John Deere dealer for MSDS's on chemical products used with John Deere equipment.)

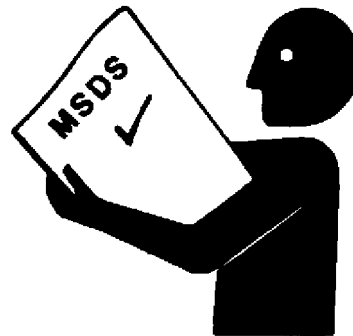

DX,MSDS,NA -19-03MAR93

TS1132
-UN-26NOV90



HANDLE PESTICIDES AND FERTILIZERS CAREFULLY

Keep dust away from skin and hair.

Keep containers low when pouring.

Let the wind blow fumes away from you when mixing with seed or when filling tank.

Wear a filtered respirator if you cannot avoid dust.

Wear goggles to protect your eyes.

Wash exposed skin areas frequently—do not leave pesticide on your skin.

Do not smoke while handling pesticides.

Properly dispose of pesticide container, unused pesticide and left-over treated seed and fertilizer.

Read and observe manufacturers recommendations.

Store pesticides in a separate, plainly marked LOCKED building.

Store pesticides in original containers with labels intact.

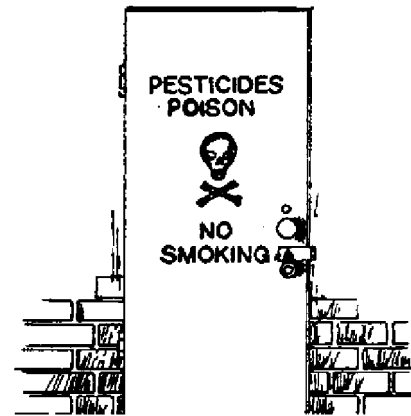

N35988 -UN-04OCT88

N35988

N35989 -UN-04OCT88

N35989

N33983 -19-31JAN89

N33983

N04.655C.A -19-05APR84



USE SAFETY LIGHTS AND DEVICES

Slow moving tractors, self-propelled equipment and towed implements or attachments can create a hazard when driven on public roads. They are difficult to see, especially at night. Avoid personal injury or death resulting from collision with a vehicle.

Whenever driving on public roads, use flashing warning lights and turn signal according to local regulation. To increase visibility, use the lights and devices provided with your machine. For some equipment, install extra flashing warning lights.

Keep safety items in good condition. Replace missing or damaged items. An implement safety lighting kit is available from your John Deere dealer.

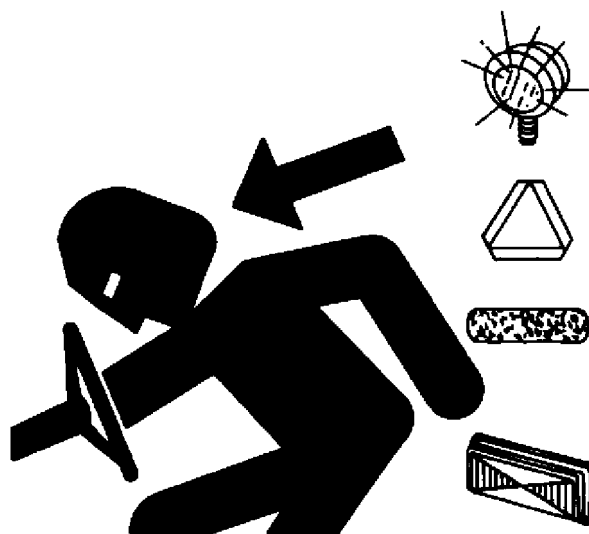

DX,FLASH -19-15MAR93

TS951 -UN-12APR90

USE A SAFETY CHAIN

A safety chain will help control drawn equipment should it accidentally separate from the drawbar.

Using the appropriate adapter parts, attach the chain to the tractor drawbar support or other specified anchor location. Provide only enough slack in the chain to permit turning.

See your John Deere dealer for a chain with a strength rating equal to or greater than the gross weight of the towed machine. Do not use safety chain for towing.

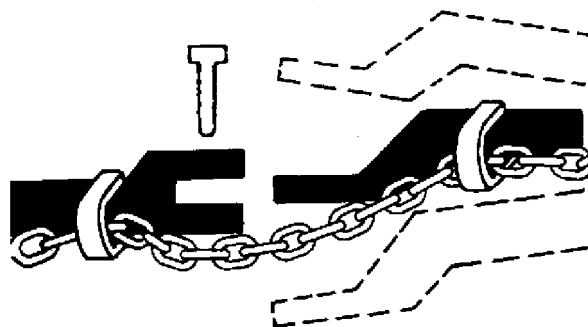

DX,CHAIN -19-03MAR93

TS217 -UN-23AUG88



REDUCE SPEED WHEN TOWING LOADS

Braking to stop towed loads from transport speeds can cause the towed load to swerve and upset. Reduce speed if towed load weighs more than the tractor and is not equipped with brakes.

Follow recommended speed-weight ratio guidelines:

- Maximum speed is 32 km/h (20 mph) when towing load equal to or less in weight than the tractor.
- Reduce speed to 16 km/h (10 mph) when towing load up to double the tractor weight.
- Do not tow loads exceeding double the tractor weight.
- Use additional caution when towing loads under adverse surface conditions, when turning, and on inclines.

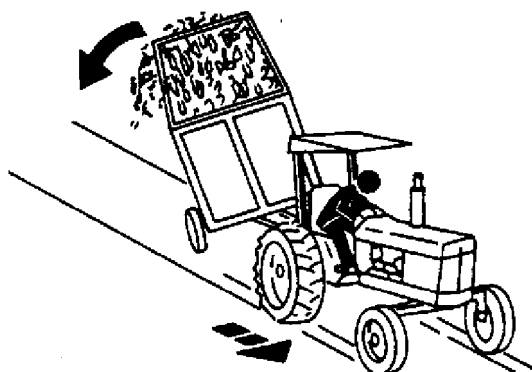

DX,TOW -19-03MAR93

TS216 -UN-23AUG68

TRANSPORT SAFELY

DO NOT fail to latch tractor brakes together.

Shift tractor into a lower gear when transporting down steep slopes or hills.

Stop slowly.

KNOW the transport height and width of your machine and beware of overhead wires.

Keep the SMV emblem and reflectors clean and visible from the rear.

DO NOT operate close to a ditch or creek or tipping can result.

Raise machine, fold wings and engage hydraulic transport lock-up by turning knob (A) fully clockwise.

Reduce speed when traveling over rough ground. Travel at a safe and reasonable speed for road and weather conditions.

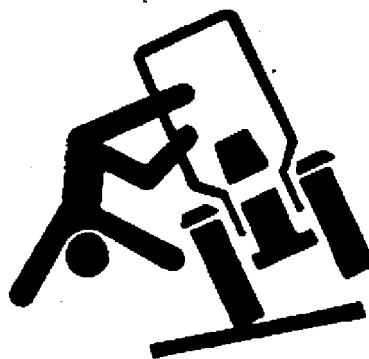

N03N,722C,B -19-05OCT93

N39084 -UN-30MAR88

N42152X -UN-16SEP93



PRACTICE SAFE MAINTENANCE

Understand service procedure before doing work. Keep area clean and dry.

Never lubricate, service, or adjust machine while it is moving. Keep hands, feet, and clothing from power-driven parts. Disengage all power and operate controls to relieve pressure. Lower equipment to the ground. Stop the engine. Remove the key. Allow machine to cool.

Securely support any machine elements that must be raised for service work.

Keep all parts in good condition and properly installed. Fix damage immediately. Replace worn or broken parts. Remove any buildup of grease, oil, or debris.

Disconnect battery ground cable (-) before making adjustments on electrical systems or welding on machine.



DX,SERV -19-03MAR93

TS218 -UN-23AUG88

REMOVE PAINT BEFORE WELDING OR HEATING

Avoid potentially toxic fumes and dust.

Hazardous fumes can be generated when paint is heated by welding, soldering, or using a torch.

Do all work outside or in a well ventilated area. Dispose of paint and solvent properly.

Remove paint before welding or heating:

- If you sand or grind paint, avoid breathing the dust. Wear an approved respirator.
- If you use solvent or paint stripper, remove stripper with soap and water before welding. Remove solvent or paint stripper containers and other flammable material from area. Allow fumes to disperse at least 15 minutes before welding or heating.

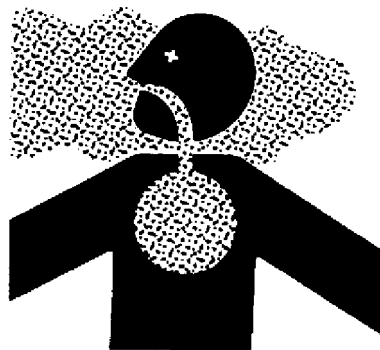

DX,PAINT -19-03MAR93

TS220 -UN-23AUG88



AVOID HEATING NEAR PRESSURIZED FLUID LINES

Flammable spray can be generated by heating near pressurized fluid lines, resulting in severe burns to yourself and bystanders. Do not heat by welding, soldering, or using a torch near pressurized fluid lines or other flammable materials. Pressurized lines can be accidentally cut when heat goes beyond the immediate flame area.



DX,TORCH -19-03MAR93

TS953 -UN-15MAY90

AVOID HIGH-PRESSURE FLUIDS

Escaping fluid under pressure can penetrate the skin causing serious injury.

Avoid the hazard by relieving pressure before disconnecting hydraulic or other lines. Tighten all connections before applying pressure.

Search for leaks with a piece of cardboard. Protect hands and body from high pressure fluids.

If an accident occurs, see a doctor immediately. Any fluid injected into the skin must be surgically removed within a few hours or gangrene may result. Doctors unfamiliar with this type of injury should reference a knowledgeable medical source. Such information is available from Deere & Company Medical Department in Moline, Illinois, U.S.A.

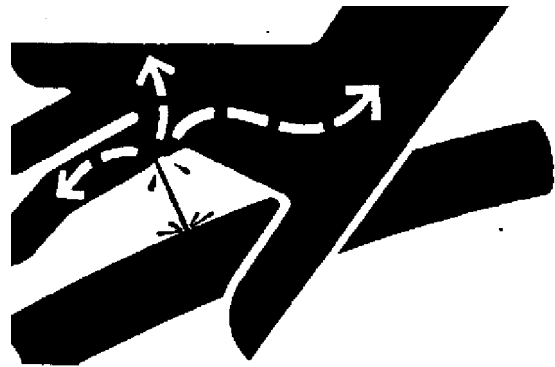

DX,FLUID -19-03MAR93

X9811 -UN-23AUG88

STORE ATTACHMENTS SAFELY

Stored attachments such as dual wheels, cage wheels, and loaders can fall and cause serious injury or death.

Securely store attachments and implements to prevent falling. Keep playing children and bystanders away from storage area.



DX,STORE -19-03MAR93

TS219 -UN-23AUG88



SAFETY SIGNS

! WARNING

Be sure cylinder and attaching hoses are fully charged with oil before operating system. Failure to do so will allow wings to fall rapidly when attempting to lower transport position.

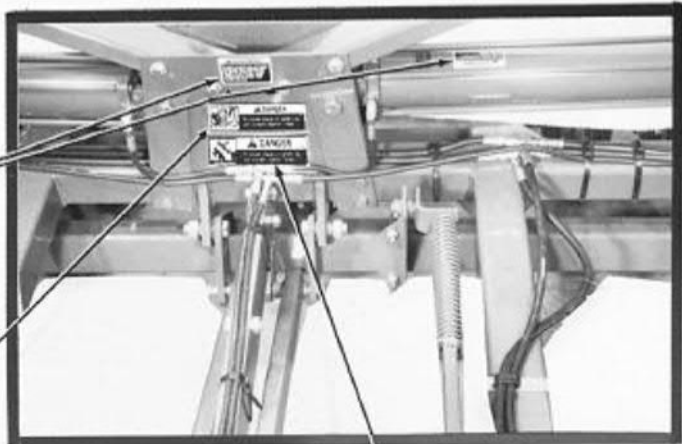

! DANGER



To avoid injury or death do not contact electric lines

! DANGER



To avoid injury or death stand clear of machine when wings are being folded or unfolded. Mechanical or hydraulic failure can allow wings to fall rapidly.

1N4N,724C,A -19-08SEP93

N42152U -19-16SEP93



! DANGER
TO AVOID INJURY OR DEATH, DO NOT ADJUST WHILE MACHINE IS IN MOTION



! WARNING
TO AVOID INJURY CLOSE LOCKUP VALVE BEFORE TRANSPORTING OR SERVICING MACHINE.

ROTATE FULLY TO LOCK

N42152V -19-16SEP93

1N4N,724C,A2 -19-08SEP93

Preparing the Tractor

PREPARING THE TRACTOR

IMPORTANT: Your mulch finisher is equipped with International Standard Organization (ISO) hose couplers. If your tractor is not compatible, see your John Deere dealer for an adapter kit.

CAUTION: Make sure PTO guard and master shield are both installed on tractor, or you or others could become entangled and severely injured or killed.

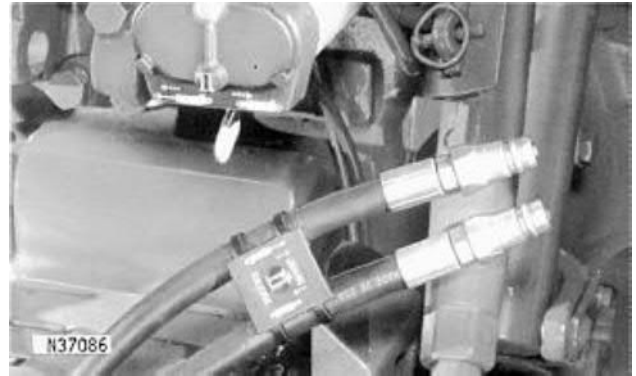

N37086 -UN-04OCT88

1. Refer to your tractor operator's manual for recommended tire inflation, use of hydraulic system, PTO, and other information on tractor with implement usage.
2. Check tire pressure; install ballast if required. See your tractor operator's manual.
3. Check tractor hydraulic oil reservoir and add oil if needed.

N03N,722V,B -19-05OCT93

CAUTION: Always pin drawbar in center position for ALL tractors when transporting for best steering control. A runaway machine can cause injury or death to you or others.

4. Center drawbar in drawbar support leaving one hole (A) clearance on each side of four-wheel drive tractors. On all other tractors, pin drawbar in center position.
5. Place drawbar in position (up or down) closest to 457 mm (18 in.) (Dimension B) from ground to top of drawbar.

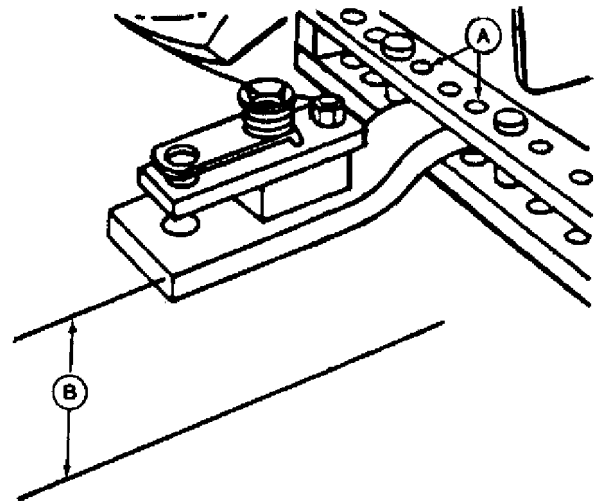

N42152W -UN-21SEP83

N03N,722V,C -19-05OCT93

Preparing the Tractor

6. Turn tractor metering valves (A) to “fast or rabbit” position.

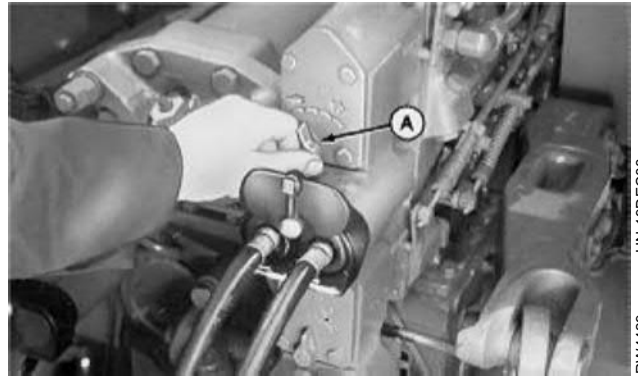

N03,722V,D -19-08JUL85

RW/4429 -UN-19DEC88

7. Secure lift links (A) and center link (B) so they do not swing into the tractor tires or onto hoses. The center link can be held vertically with its retaining clip.

8. Safety chains are recommended to secure hitch to tractor. All tractors must be equipped with an intermediate chain support ahead of hitch pin. See your John Deere dealer.

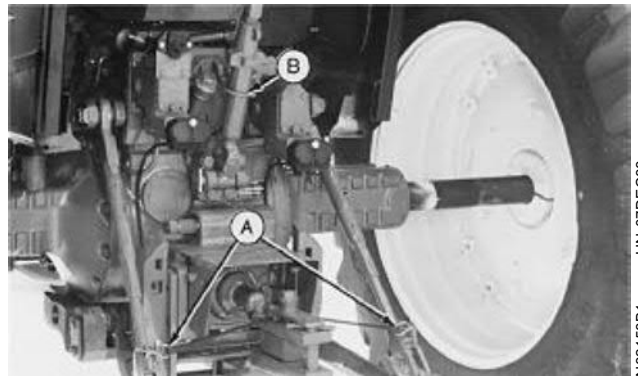

N03,722V,A -19-08JUL85

N82158B1 -UN-07DEC88

Preparing the Machine

CHECK TIRE PRESSURE

9.5L x 15 - 8 PR—275 kPa (2.7 bar) (40 psi)- tandem wheel

7.60 x 15 - 6 PR—248 kPa (2.5 bar) (36 psi)- single wheel

20.5 x 8 - 10—241 kPa (2.4 bar) (35 psi)- optional stabilizer wheel for 5.9 m (19 ft 4 in.) models

N03,7221,A -19-14SEP92

LEVEL THE MULCH FINISHER

Locate machine on flat ground; then level machine. (See Leveling Mulch Finisher in the Operating Section.)

N03,722,PFB -19-23JUL91

LUBRICATE MULCH FINISHER

Follow proper procedures outlined in the Lubrication and Maintenance Section.

N03,722,PFC -19-23AUG83

Thank you so much for reading.
Please click the “Buy Now!”
button below to download the
complete manual.



After you pay.

You can download the most
perfect and complete manual in
the world immediately.

Our support email:

ebooklibonline@outlook.com